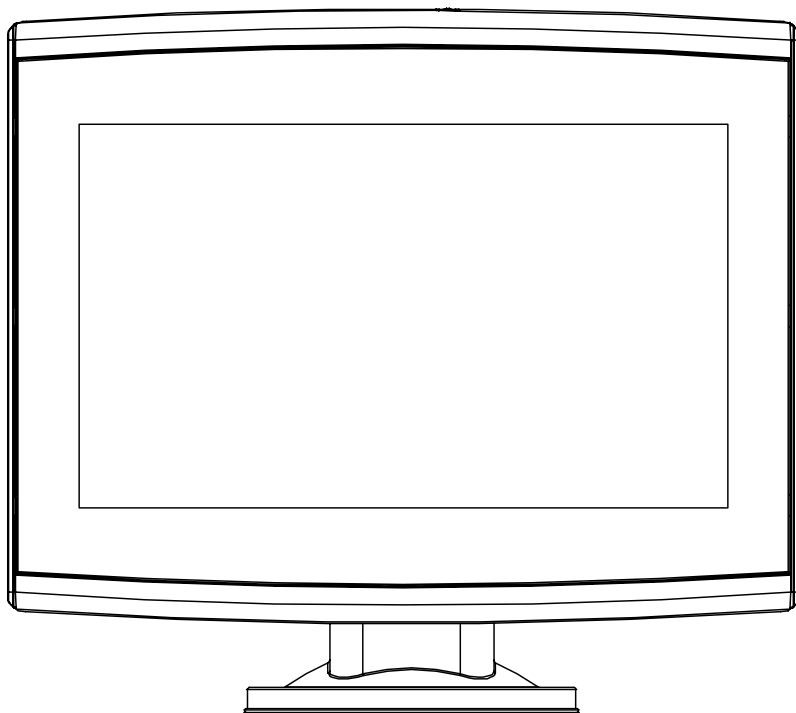


AvMAP

SATELLITE NAVIGATION



G7[®] FARMNAVIGATOR

USER MANUAL

Updated to 3.10.xR software version
(where x indicates all 3.10 software versions)

Index

1. Introduction	5	3.2.6 Auto-Steering system (For G7 Plus only)	42
1.1 Ways of using G7 Farmnavigator	5	3.2.7 Nudge	43
1.2 Electrical wiring harness	5	4. Advanced operating modes	45
1.3 How to install the antenna Turtle Smart	6	4.1 Start new job, full mode	45
1.3.1 How to connect Turtle Smart antenna to G7 Farmnavigator	6	4.2 Define the field and create new A-B guidelines	45
1.3.2 Antenna Position– Transverse Axis	6	4.3 Working again on defined A-B lines using the same implement	46
1.3.3 Antenna position - Longitudinal axis	6	4.4 Working on predefined A-B lines but with another implement	47
1.3.4 Antenna position – Height	7	4.5 Create more than one A-B line during the same job session	48
1.4 Turning the device On	7	4.6 Change A-B lines during the same Job	49
1.5 How to use multi-touch display	8	4.7 Move the line to a specific point, "Magnet" function	50
2. Main menu and basic operations	9	4.8 Move A-B line according a precise value, "Street" function	51
2.1 DATABASE Menu	9	4.9 Connect an external device to control sections	51
2.1.1 DRIVERS	10	5. Importing and exporting data	62
2.1.2 FARMERS	11	5.1 Download a job and view it in the office	62
2.1.3 FIELDS	12	5.2 Import the field boundaries in KMZ format	63
2.1.4 PRODUCTS	13	5.3 Importing a map in SHP file format	65
2.1.5 LAVORI	13	5.3.1 Create a boundary in SHP file format	68
2.1.6 IMPLEMENTS	13	6. Other functions	70
2.2 New Job Menu	19	6.1 G7 Farmnavigator software updates	70
2.3 Continue Last Job Menu	22	6.1.1 Software Update via WiFi (G7 Plus only)	70
2.4 Configuration Menu	23	6.1.2 Software Update via USB	70
2.4.1 Units of measurement	23	6.2 Video camera	71
2.4.2 User preferences	24	6.2.1 Type of supported cameras	71
2.4.3 Satellites	24	6.2.2 Connect a video camera	71
2.4.4 GPS antenna position on the tractor	25	6.2.3 Display mode for Video camera	71
2.4.5 Auto-Steering (for G7 Plus only)	26	6.3 G7 Navi (Only for G7 Plus)	72
2.4.6 Work view layout	26	6.4 Activate a virtual NMEA output on the "Generic" port	73
2.4.7 Remote control (for G7 Plus only)	27	6.5 Activate the demo mode	74
2.4.8 Wireless connectivity (for G7 Plus only)	29	7. Contacts/Customer Support	76
2.4.9 Mirror Control (for G7 Plus only)	29	8. Appendix	77
3. Job page	32	Analytic Index	78
3.1 Current job information	32		
3.1.1 Job name	32		
3.1.2 Connected devices	32		
3.1.3 Precision and reception of the antenna	33		
3.1.4 Zoom Level and compass	33		
3.1.5 Area, speed, distance	34		
3.2 Operative functions during Job	34		
3.2.1 Start/stop	34		
3.2.2 A-B lines	34		
3.2.3 Field	37		
3.2.4 Headlands	39		
3.2.5 Obstacles	41		

1. Introduction

1.1 Ways of using G7 Farmnavigator

Thank you for choosing AvMap G7 Farmnavigator!

Now you have the opportunity to:

- Map your fields
- Set up and save your implements
- Create guidelines for your activities
- Save all the activities done in the field
- Configure the spray boom and have section control directly on the display during your treatments
- Control sections automatically, when a compatible device is connected to G7 Farmnavigator
- Import and export you jobs and see them on Google Earth™
- Connect Auto-Steering Kit to take full advantage of driving capabilities
- Save the position of obstacles on the work area
- Connect a camera and control it from G7 Farmnavigator display
- Use Terrestrial Navigator (only for G7 Plus Farmnavigator, hereinafter referred to as G7 Plus)

1.2 Electrical connections

G7 Farmnavigator is provided with a bracket and a wiring with connectors to ensure an easy and safe installation on your tractor.

Wiring harness consists of a 2A protection fuse.

The supply voltage must be within the range 10-35 Vdc

Follow the instructions included in the package.

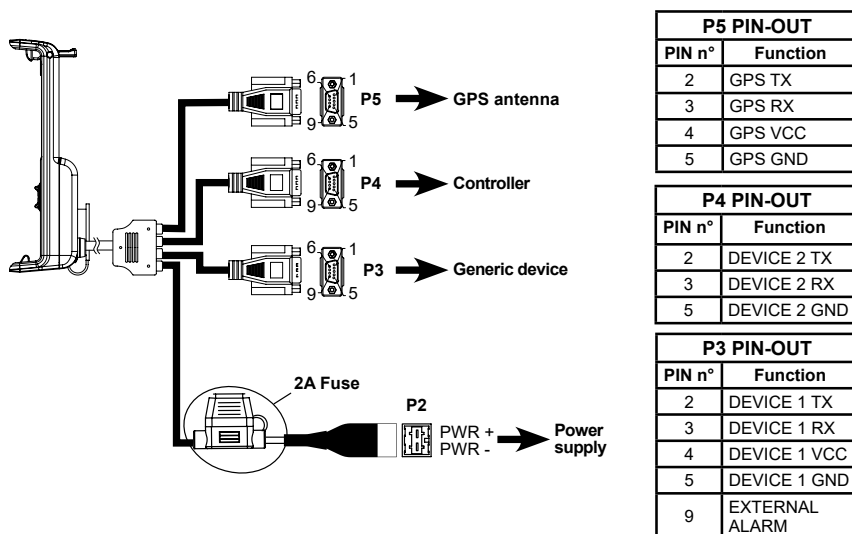


Figure 1.2.a - Electrical connections

1.3 How to install Turtle Smart antenna

The procedure described below refers to Turtle Smart antenna, since it is entirely produced by AvMap and it is the most common type of antenna used by our clients. (Please, contact the assistance if you need clarifications about the installation of third-party antennas).

Turtle Smart is provided with three magnets which ensure a quick installation on a ferromagnetic surface.

1.3.1 How to connect Turtle Smart antenna to G7 Farmnavigator

Turtle Smart antenna is provided with a 9-pin serial cable which transfers data and power supply between G7 Farmnavigator and Turtle Smart antenna.

Turn off the device, and connect the 9-pin serial cable to the cable located on the bracket, marked with "GPS Antenna".

1.3.2 Antenna position– Transverse axis

The antenna must be located in the exact centre of the tractor. Carefully measure the exact centre of the tractor to determine the central axis.

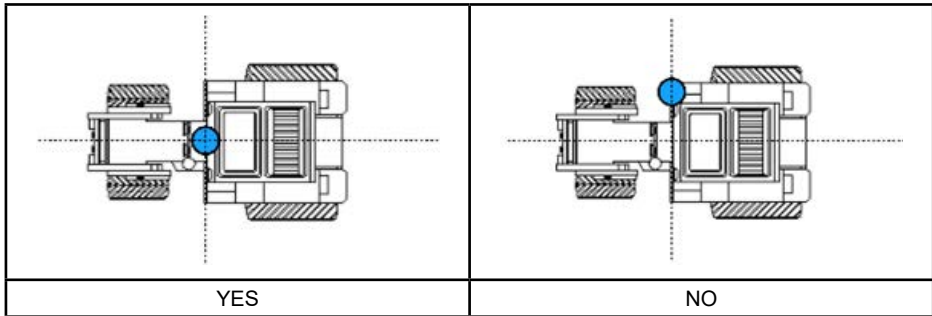


Table 1.3.a How to install the antenna - Transverse Axis

1.3.3 Antenna position - Longitudinal axis

It is advisable to locate the antenna as close as possible to the front steering axles.

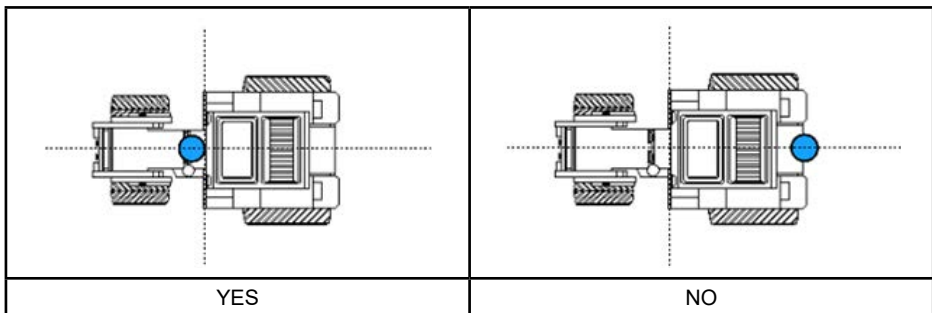


Table 1.3.b How to install the antenna – Longitudinal Axis

1.3.4 Antenna position – Height

The effects of antenna height have to be considered in case of jobs on steep sloping grounds. In these cases, it is recommended to install the antenna on the front of the tractor so as to reduce tilt and oscillation error.

In all other cases (jobs on the level ground), the antenna may be positioned on the top of the tractor.

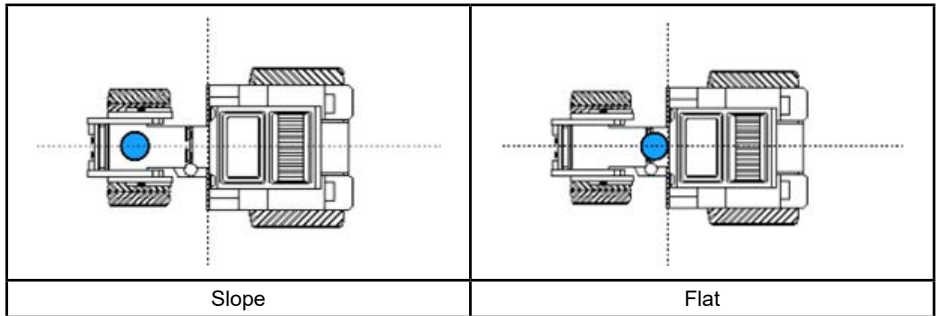


Table 1.3.c How to install the antenna – Height

1.4 Turning the device on

Before turning G7 Farmnavigator on, make sure the display is connected to the bracket. Check that the bracket is firmly anchored to the tractor and that the power cable is plugged into 12V socket.

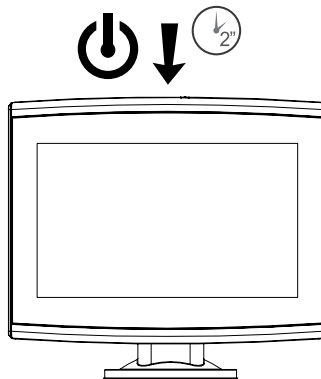


Figure 1.4.a Turning on the display

1. Press and hold the button located in the upper right corner of the display for 2 to 3 seconds;
2. Once the device is on, the logo will be displayed on the screen;
3. Once loading is completed, a warning section will appear on the screen. Please, read it carefully and press OK to accept and continue, and open the main menu.

NOTE: when turning the device on for the first time, you must select the language.

To turn the display off:

1. Press and hold the power button for 2 to 3 seconds;
2. Press "YES" to turn the device off.

It is possible to reset G7 Farmnavigator if the device cannot be normally turned on/off. The reset button is located at the left of the power button, below the plastic cover.

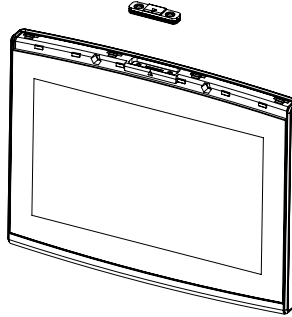


Figure 1.4.b Reset the device

How to reset the device:

1. Press the button;
2. Wait for the device to reset.

ATTENTION: a reset of the device might cause data loss.

1.5 How to use multi-touch display

G7 Farmnavigator is provided with a multi-touch display which allows you to perform specific actions with your fingers.





	Tap the screen to select a button from the menu.
	Move your finger to scroll through the menu or scroll through the pages.
	Slide the fingers closer together or further apart to zoom in or zoom out the field.
	Touch the screen with two fingers simultaneously to rotate the field.

Table 1.5.a Touch screen gestures and movements

2. Main menu and basic operations

Below are the basic operations for the creation of a new job, system settings, the creation of a new implement and working methods.



Figure 2.0 - Main menu

2.1 DATABASE menu



Figure 2.1.a DATABASE menu

Farmnavigator functions are designed to save and precisely organize all the information relating to each single job. It is advisable to enter data from the outset, in order to fully exploit all the advantages of this technology.

Through DATABASE menu, it is possible to manage all your data (insertion, visualization, editing, elimination, exportation).

2.1.1 DRIVERS

It is possible to save all DRIVERS name.

1. Select "Add new";
2. Enter the name, and select "OK";
3. Tap the green arrow in the upper left corner of the screen to go back to the previous page.



Figure 2.1.b Add a new driver

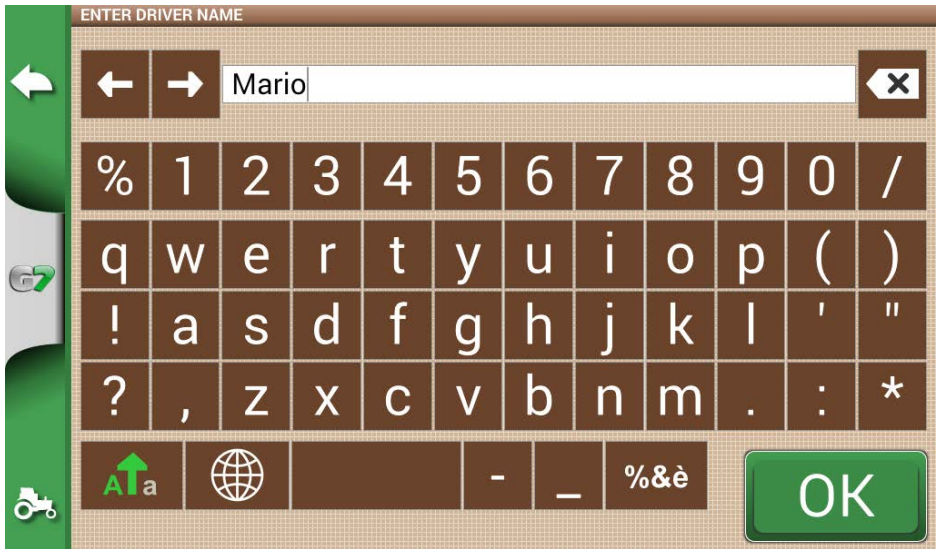


Figure 2.1.c Driver name

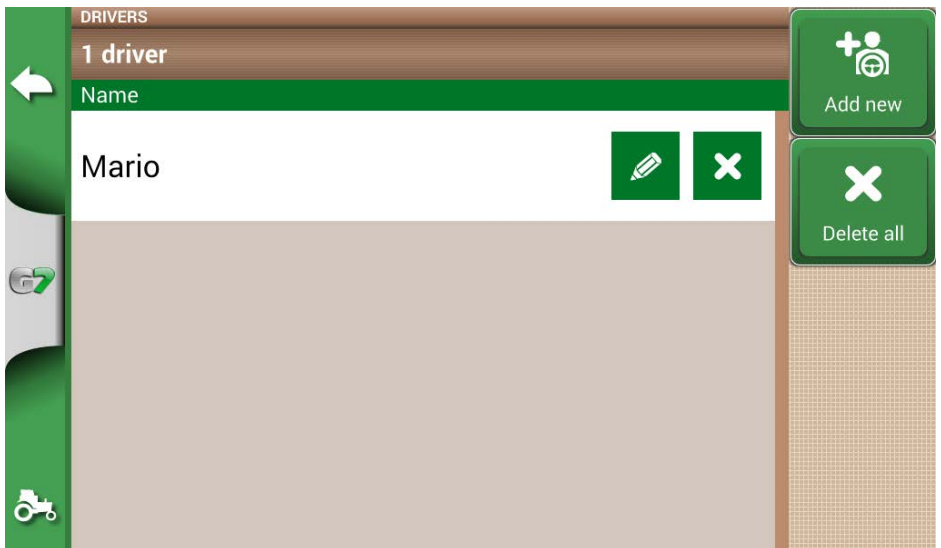


Figure 2.1.d List of drivers

2.1.2 FARMERS

It is essential to save FARMERS name. FARMERS refer to all customers or landowners. If a company has the ownership of all the worked lands, insert the name of the company in the FARMERS section.

1. Select "Add New";

2. Insert the name, and select "OK";
3. Tap the green arrow in the upper left corner of the screen to go back to the previous page.

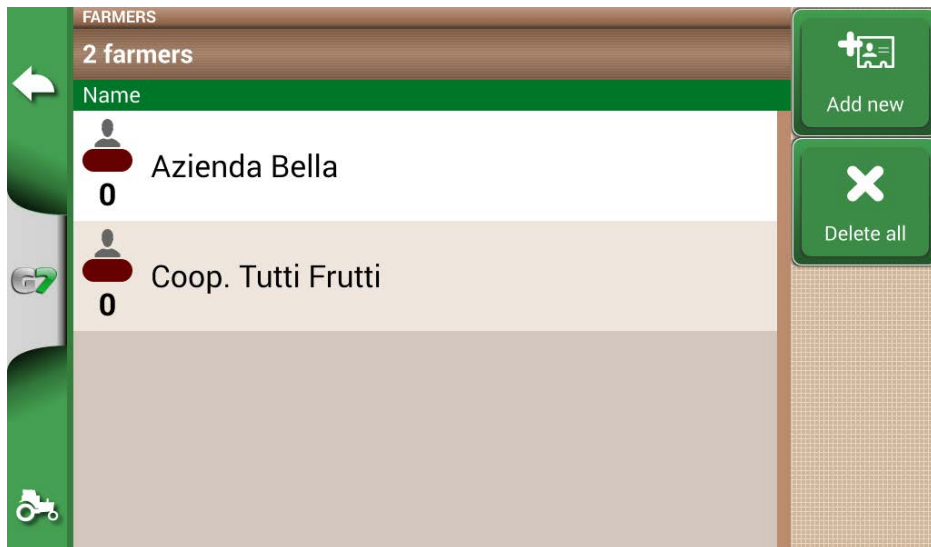


Figure 2.1.e List of farmers

2.1.3 FIELDS

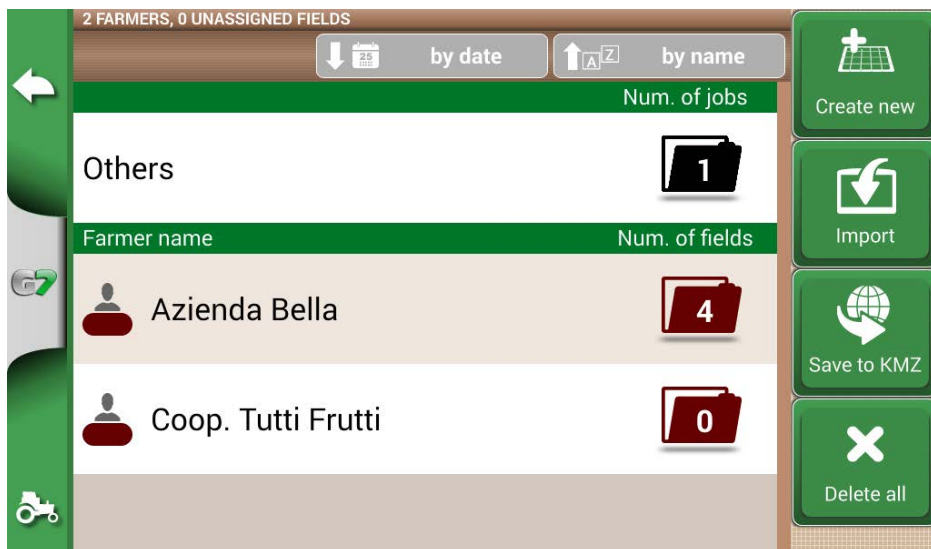


Figure 2.1.f List of fields associated with farmers or others

It is possible to collect and save all the parcels of land worked or that must be worked. FIELD are associated with FARMERS:

1. Select farmer name;
2. Select "Add New";
3. Insert the name, and select "OK";
4. Tap the green arrow in the upper left corner of the screen to go back to the previous page.

2.1.4 PRODUCTS

G7 Farmnavigator allows you to create a list of products and save their use after each activity.

1. Select "Add New";
2. Insert the name, and select "OK";
3. Tap the green arrow in the upper left corner of the screen to go back to the previous page.

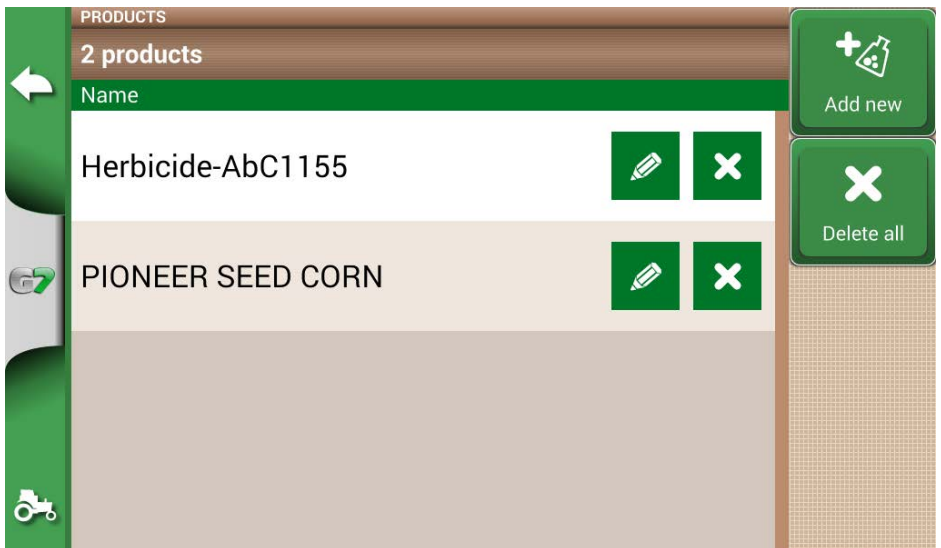


Figure 2.1.g List of products

2.1.5 JOBS

Jobs are created automatically through the procedures described below.

2.1.6 IMPLEMENTS

In the IMPLEMENTS page, it is possible to create and configure all the implements that will be used with G7 Farmnavigator.

1. Select "Add New";
2. Insert the name, and select "OK";

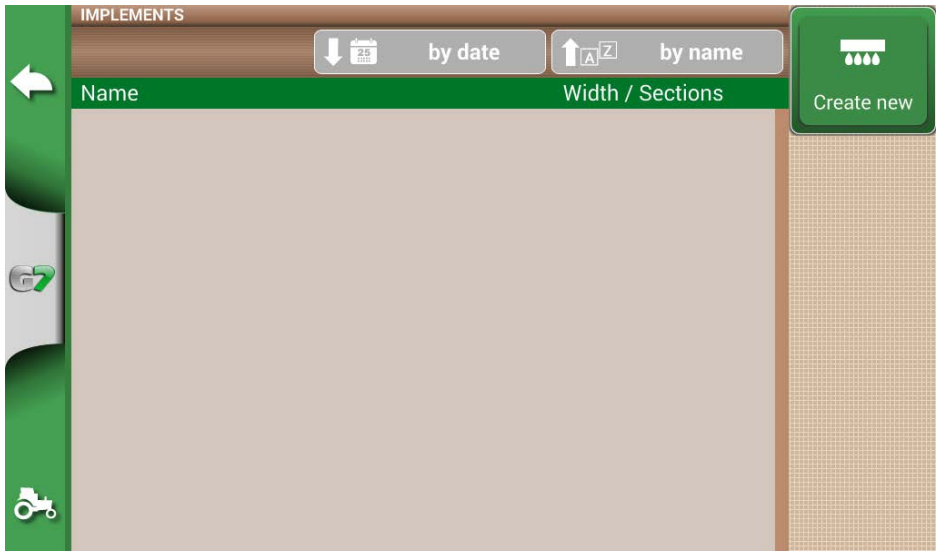


Figure 2.1.h IMPLEMENTS menu

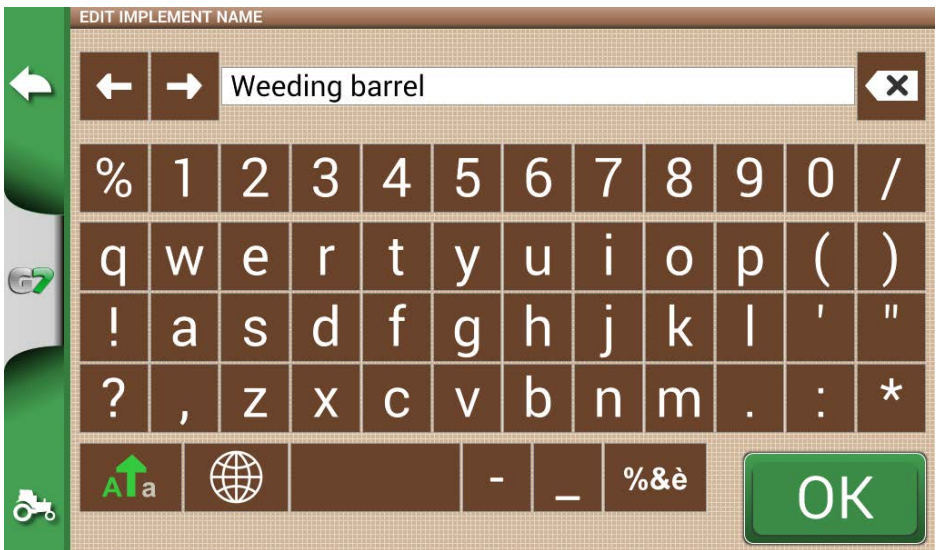


Figure 2.1.i Implement name

3. If active, select the external controller type. Select "No section control" to use the implement without section control.

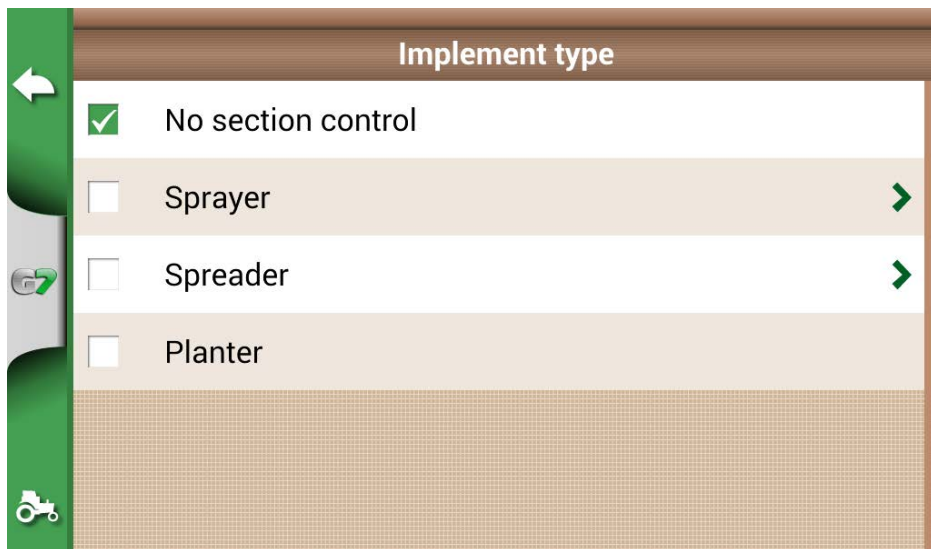


Figure 2.1.j External control unit connection

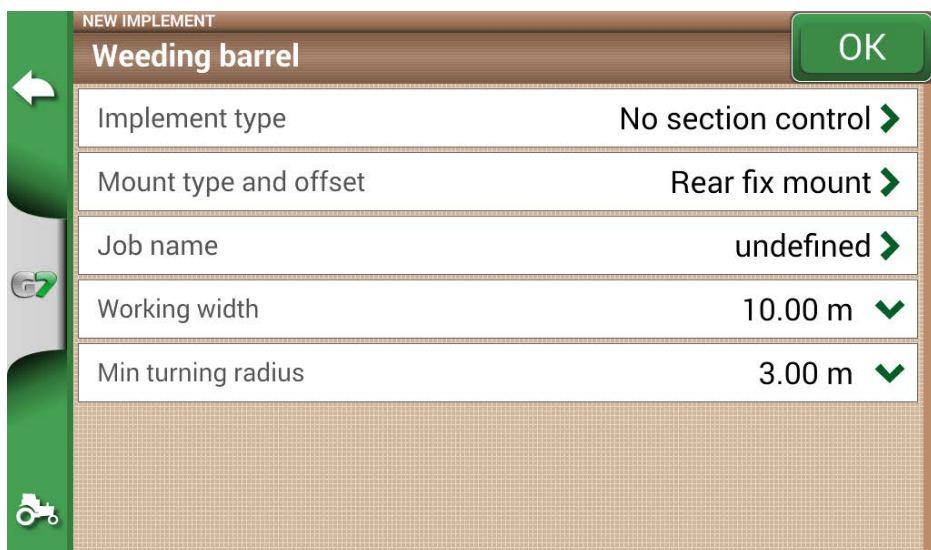


Figure 2.1.k Implement setting

4. Select "Assembling type and offset";
5. If the implement is mounted, tap "REAR FIX MOUNT";
 - Offset 1 refers to the distance between the posterior axle and the implement operating point.
 - Offset 2 refers to an eventual misalignment between the implement and the centre of the tractor.

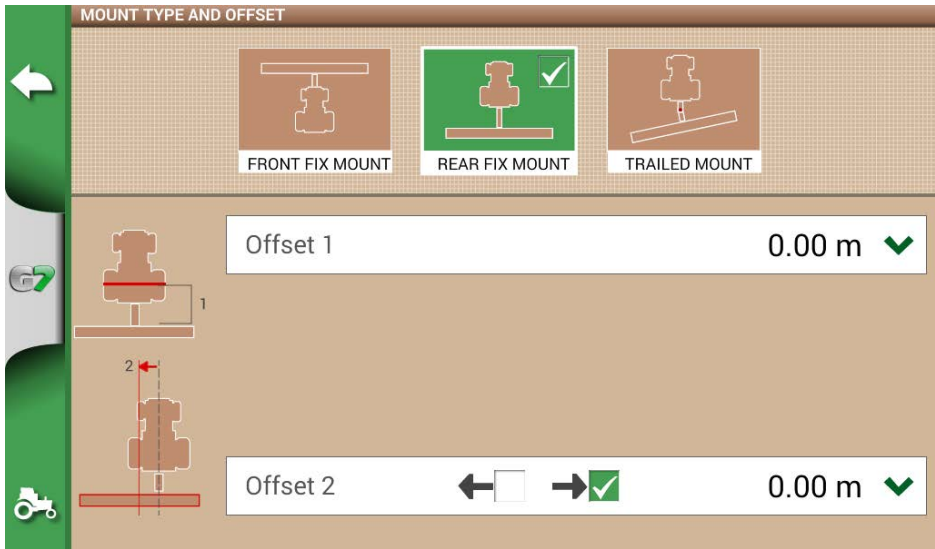


Figure 2.1.l Rear fix mount implement

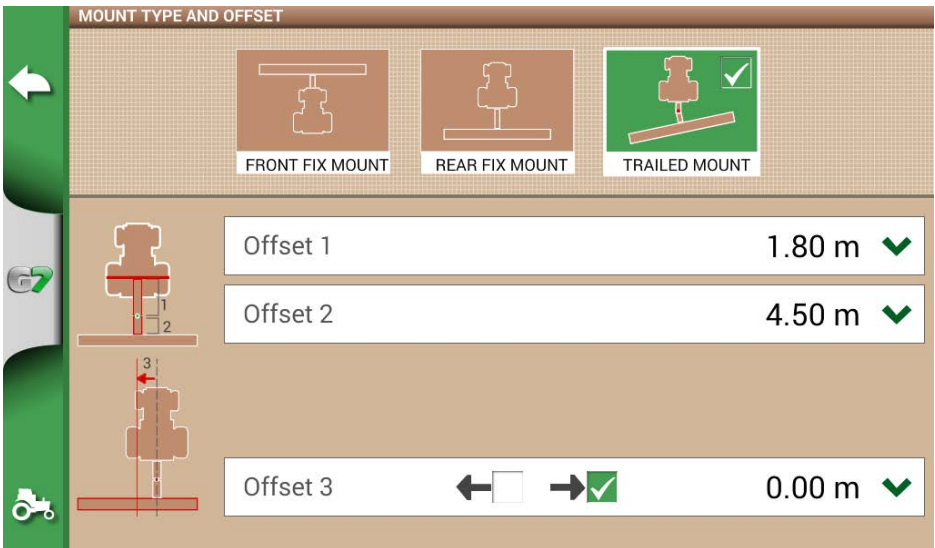


Figure 2.1.m Trailed mount

6. In case of towed implement, select "TRAILED MOUNT";
- Offset 1 is the distance between the posterior axle and the junction;
 - Offset 2 is the distance between the junction and the implement operating point;
 - Offset 3 refers to a possible misalignment between the implement and the centre of the tractor;

7. Tap the green arrow in the upper left corner of the screen to go back to the previous page;
8. Select "Job type" to enter the type of job performed by the implement;

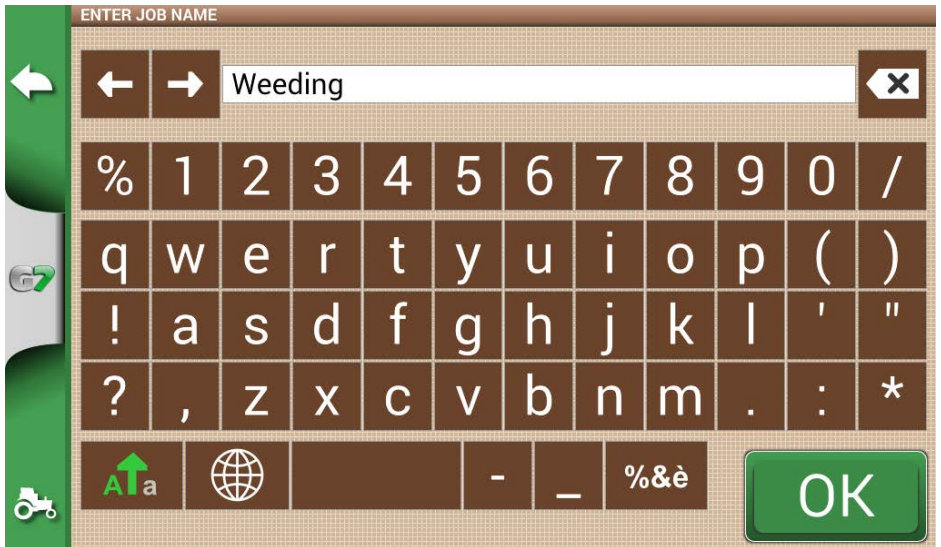


Figure 2.1.n Implement main activity

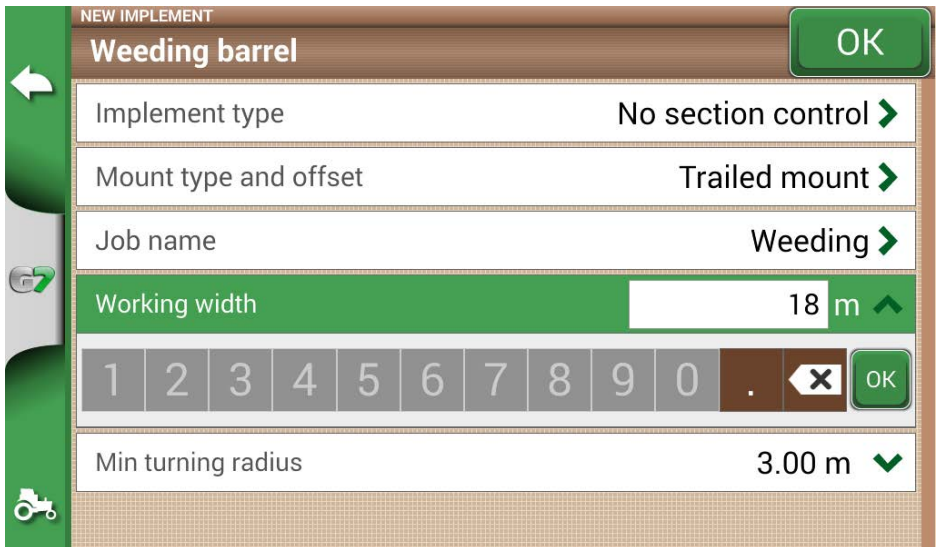


Figure 2.1.o Working width setting

9. Tap "Working width", insert implement width, and select "OK";
10. Tap "Minimum turning radius" and insert the turning value indicated in the tractor registration certificate, and select "OK";

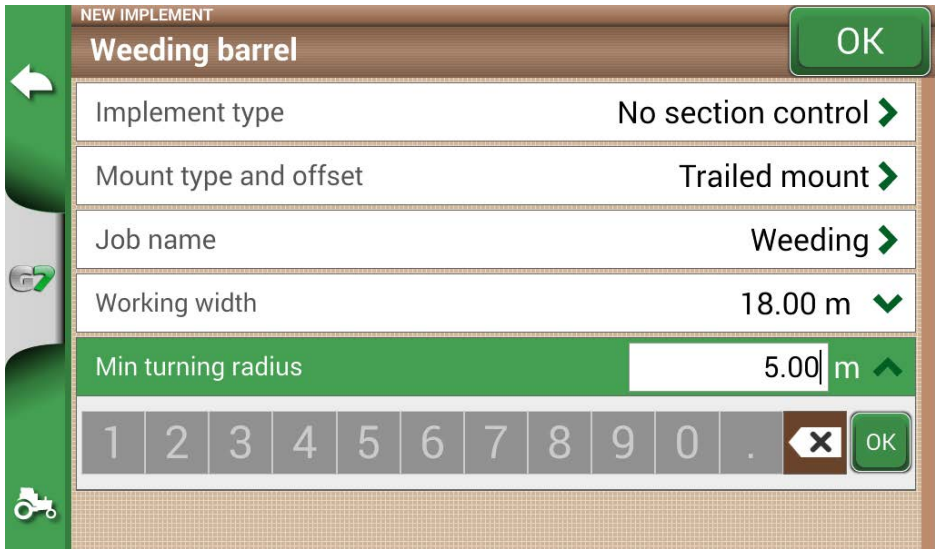


Figure 2.1.p Tractor minimum turning radius setting

11. Select "OK" in the upper left corner of the page to confirm;

All the information needed are now entered. From the database menu, it is always possible to add, edit and delete the information entered.

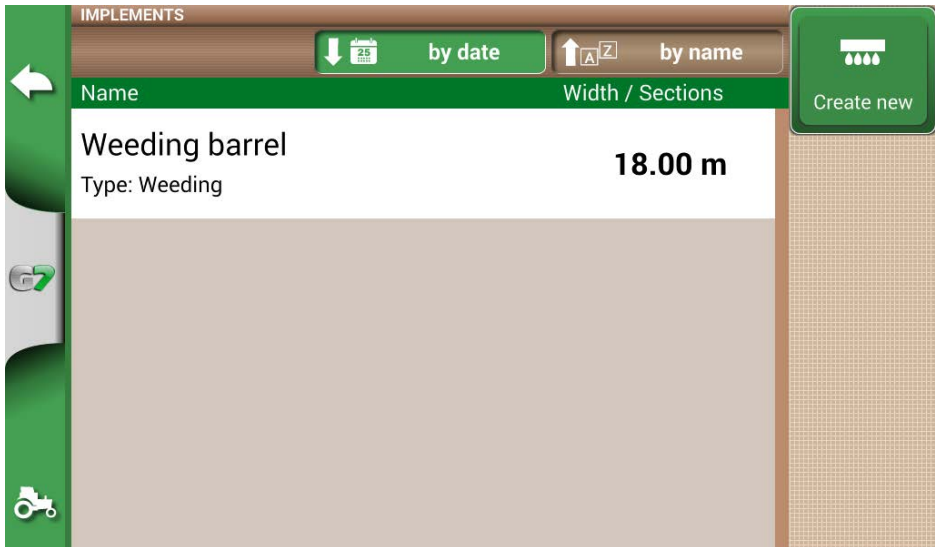


Figure 2.1.q List of saved implements

2.2 New job menu

To create a new job in fast mode, that is without entering all the working parameters and starting with your job:

1. Select "START NEW JOB";
2. Select the implement from the "IMPLEMENT" line, tapping the downward green arrow;

START	
FARMER	Undefined
FIELD	Undefined
JOB	New
IMPLEMENT	Seeder, 4.50 m
DRIVER	Undefined
PRODUCTS	Herbicide-Abc1155
WEATHER	

Figure 2.2.a Start new job page

SELECT IMPLEMENT	
Name	Width / Sections
Seeder Type: Seeder	4.50 m
Weeding barrel Type: Weeding	18.00 m

Figure 2.2.b List of implements

3. Select the name of the implement;
4. Select “OK” to switch to the job page;

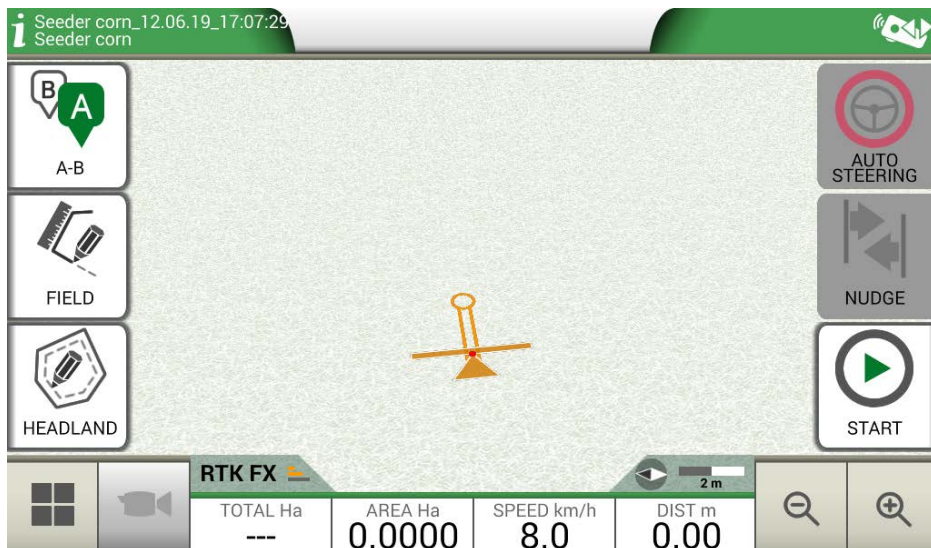


Figure 2.2.c Job page

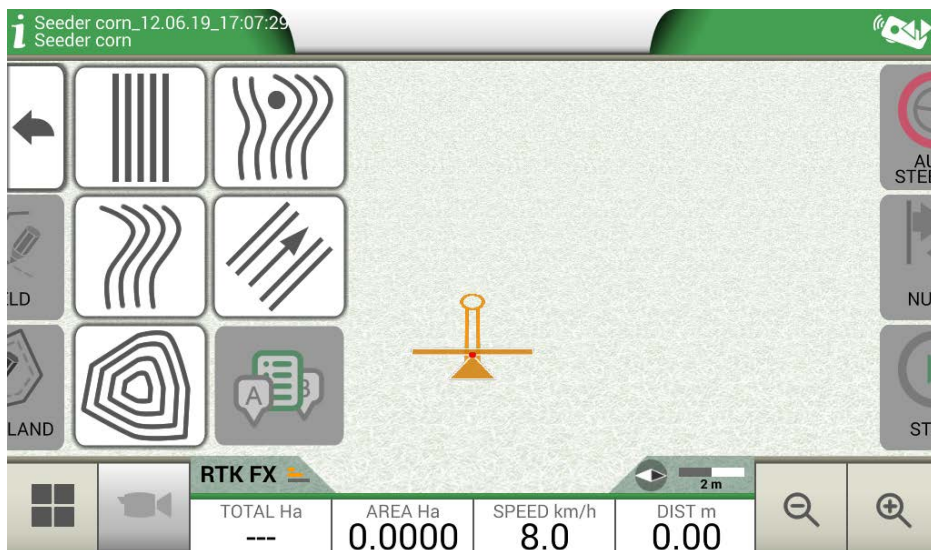


Figure 2.2.d Job type selection

5. Select “A-B” to start the job;
6. Select the type of guidelines, for example A-B parallel guidelines;



A-B parallel guidelines

Tap this icon to work with A-B parallel guidelines.

Table 2.2.e A-B straight lines

- Tap the icon to save point A;
- Proceed few metres straight ahead to save point B;

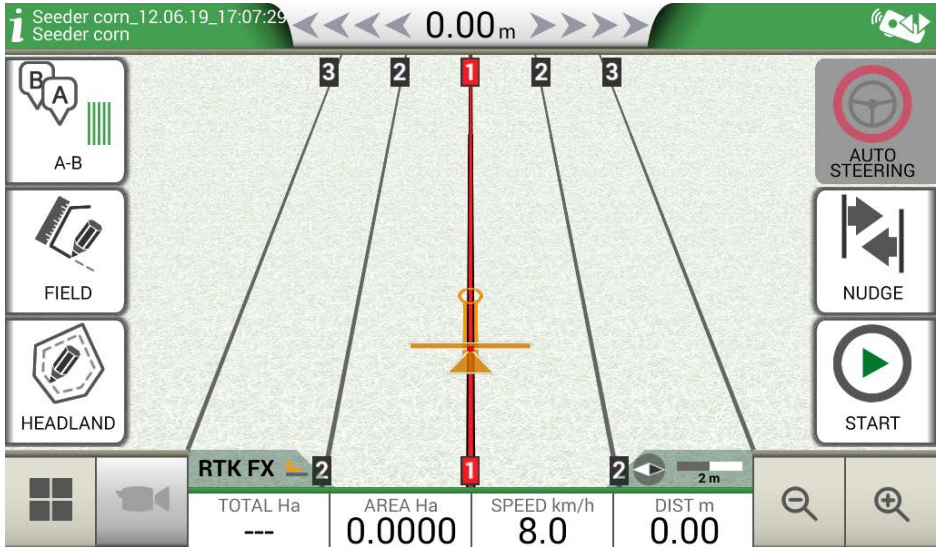


Figure 2.2.f Parallel lines

- A-B lines are now created;
- Follow both the line direction displayed at the top of the page and the guidance cursor to maintain the correct trajectory of the vehicle.

	<p>Distance Distance between the tractor and the A-B guideline. The green cursor indicates how to turn the steering wheel so as to correct the trajectory.</p>
	<p>Smart cursor The smart cursor is provided with two lines. It helps user to maintain the tractor aligned with the direction of the A-B guideline.</p>

Table 2.2.g Distance from guideline and smart cursor

2.3 Continue last job menu

G7 Farmnavigator allows you to continue the last job, accessing it directly from the Main Menu:

1. Select “CONTINUE LAST JOB” from the main menu;
2. This page shows you all the information about your last job. Select “OK” to confirm;



Figure 2.3.a Main menu – Continue last job

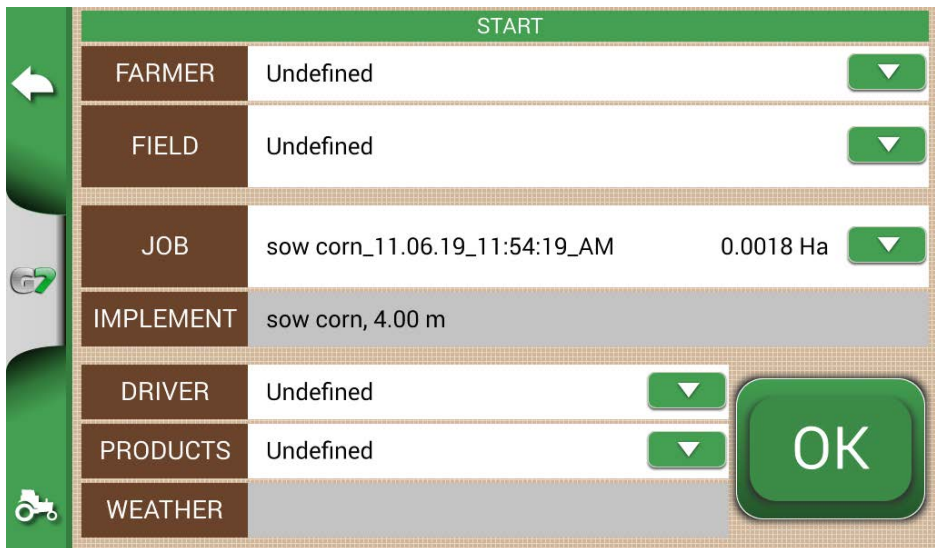


Figure 2.3.b Last job confirmation page

3. The project will be loaded. Now it is possible to continue the job.

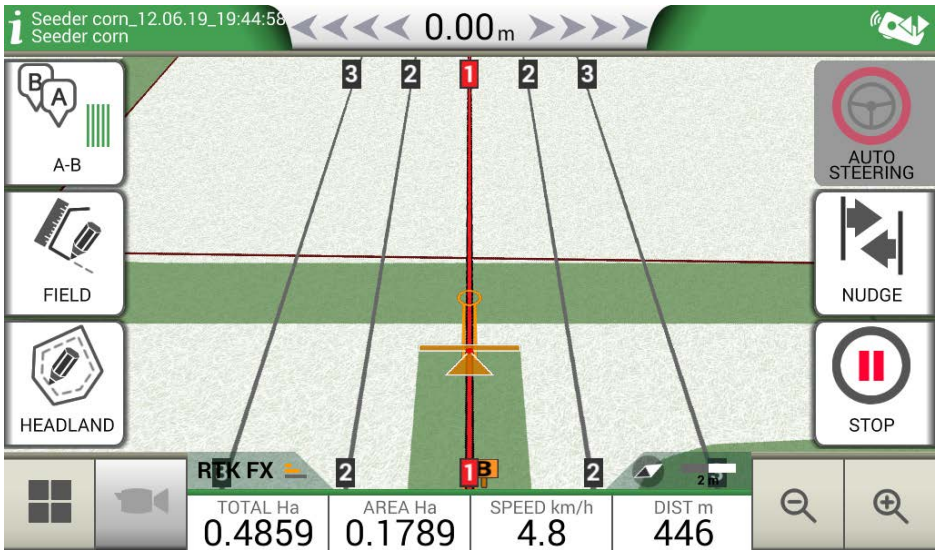


Figure 2.3.c Last job and latest position visualization

2.4 Configuration menu

From the “CONFIGURATION” menu, it is possible to access different settings, parameters and customization.

2.4.1 Units of measurement

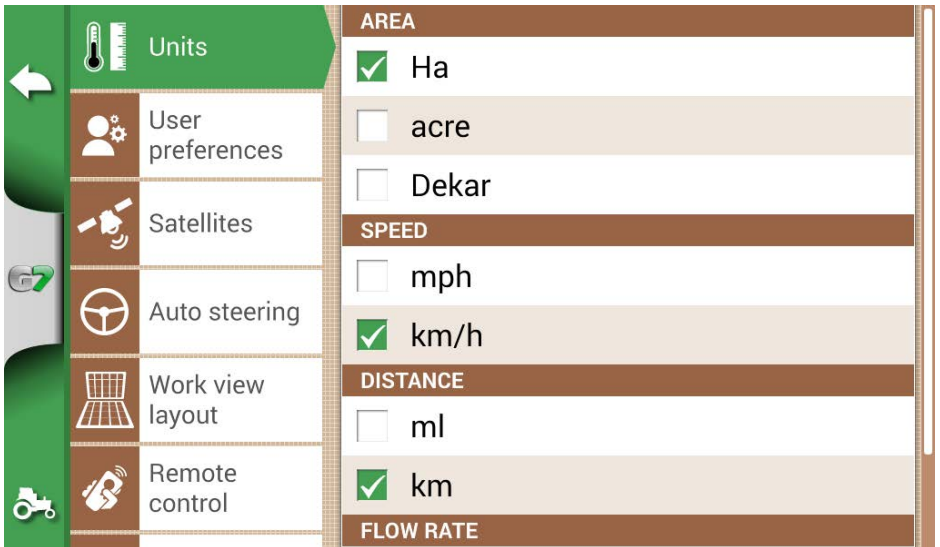


Figure 2.4.a Units of measurement

It is possible to configure unit of measurement for area, speed and distance:

1. Tap on "CONFIGURATION" > "Units";
2. Select the unit that you need to modify;
3. Select the required unit of measurement;

2.4.2 User preferences

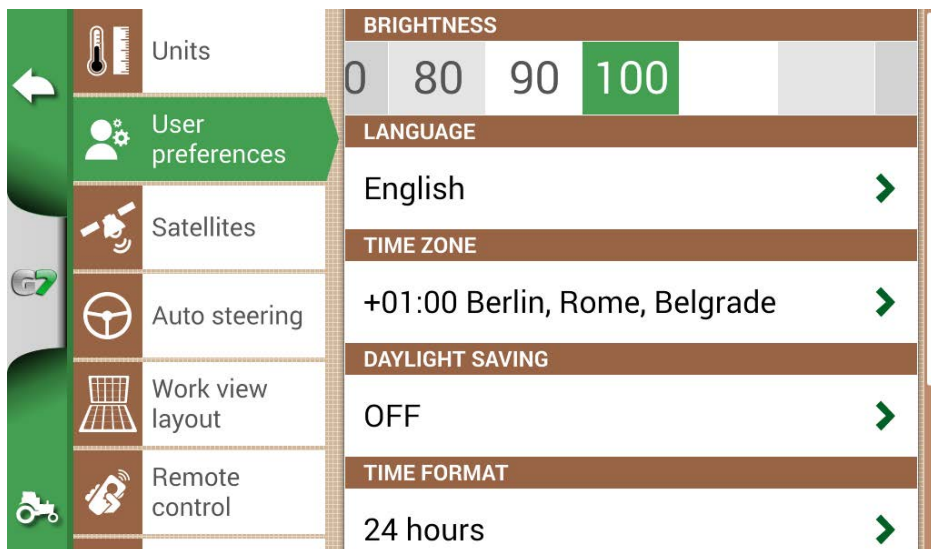


Figure 2.4.b User preferences page

It is possible to configure and edit user preferences:

1. Select "CONFIGURATION" > "User Preferences";
2. Select the preference that has to be changed and tap the arrow to change it.

2.4.3 Satellites

This page allows you to check the satellites status and change the settings of the GNSS receiver. GNSS settings may vary depending on the type of GNSS, for this reason the menu may look differently from one type to another.

1. Select "CONFIGURATION" > "Satellites";
 - MINIMUM SPEED LIMIT: This value should be close to 0 km/h only if you are using a high precision receivers (RTK).

ATTENTION: It is strongly recommended to modify this parameter only after receiving confirmation from technical support;

- REVERSE DETECTION: this feature indicates if the tractor is driving forward or in reverse. When active, if the direction of travel is detected incorrectly, tap "Forward Direction" to restore normal functioning;
- SATELLITES INFORMATION: this page displays the map of satellites and their signal strength. In order to guarantee a correct functioning of the device, the majority of the satellites must be coloured in green. Otherwise, wait at least 20 minutes in an open-space and dust the antenna with a wet rag.

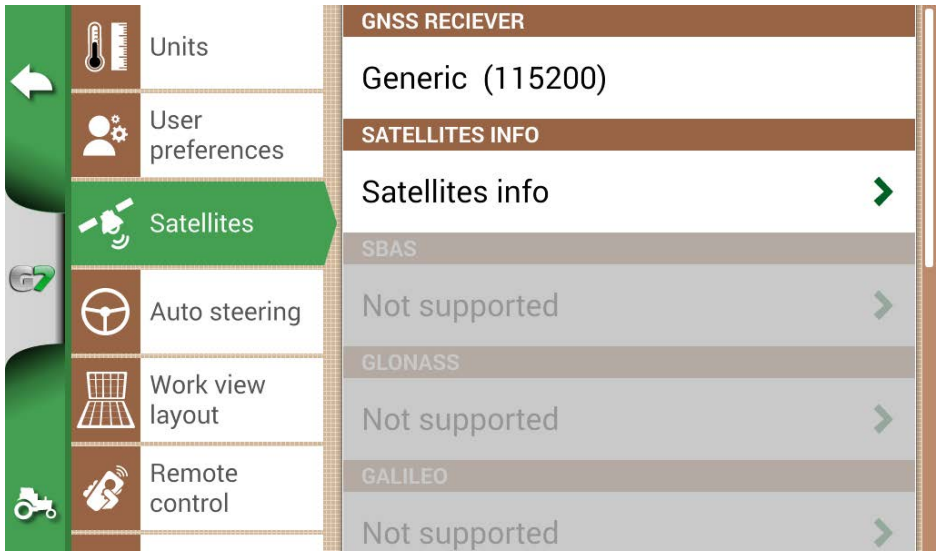


Figure 2.4.c Satellites configuration page

2.4.4 GPS antenna position on the tractor

This parameter refers to the position of the GPS antenna in relation to the posterior axel of the tractor.

1. Enter the distance value accurately and select "FORWARD" if the antenna is located in front of the axel; select "BACKWARD" if it is located behind the rear axle.

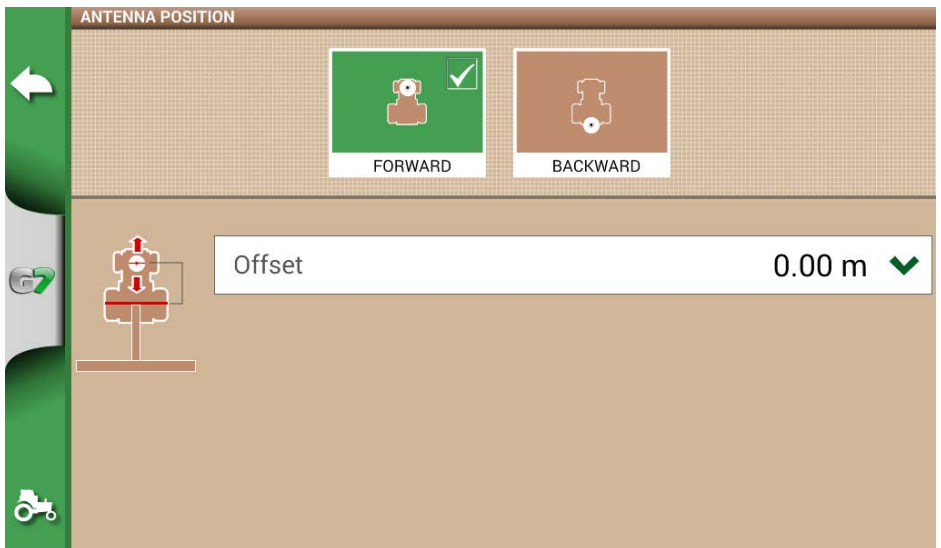


Figure 2.4.d Antenna position in relation to rear axle

2.4.5 Auto-Steering (for G7 Plus only)

Auto-Steering menu allows you to access G7 Farmnavigator settings when it is connected to Auto-Steering system.

1. Select "SETTINGS" > "Auto-Steering";

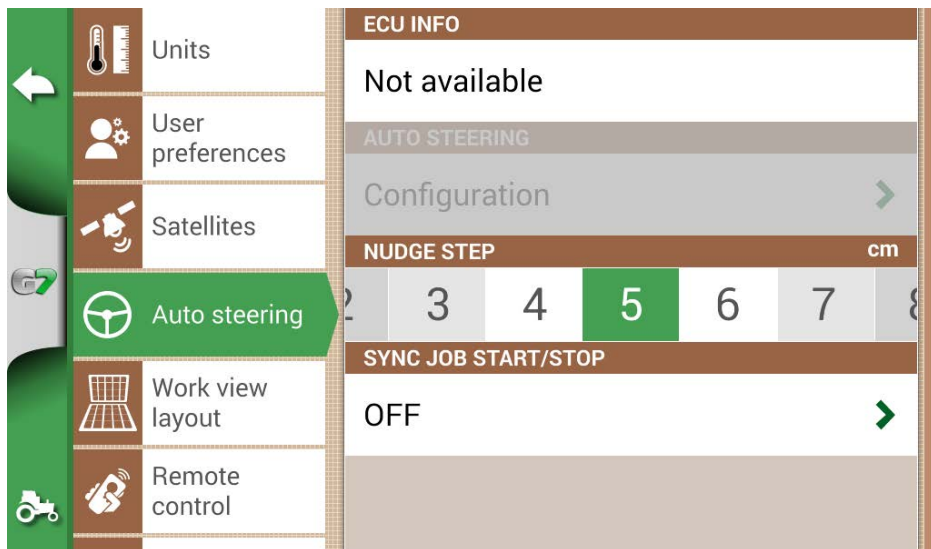


Figure 2.4.e Auto-Steering configuration page

In this page it is possible to find:

- ECU INFO: information about ECU-S1 steering controller connected to G7 Farmnavigator;
- AUTO-STEERING: it is possible to open Auto-Steering advanced menu settings

ATTENTION: this feature is limited to expert users. An incorrect configuration leads to a malfunction of the Auto-Steering system;

- NUDGE STEP: it is possible to configure a default displacement value for the function "Move";
- SYNC JOB START/STOP: set this function "ON" and select Auto-Steering button to start colouring the worked area.

2.4.6 Work view layout

Work view layout menu allows you to edit the map view.

1. Select > "SETTINGS" > "Work view Layout";
 - MAP VIEW: select 2D to have a view from above or 3D for a perspective view;
 - DAILY BACKGROUND: allows you to change the background colour of the map;
 - SCALE GRID: it allows you to create a grid on the background. It is possible to configure grid size manually.

NOTE: grid orientation always refers to geographical North.

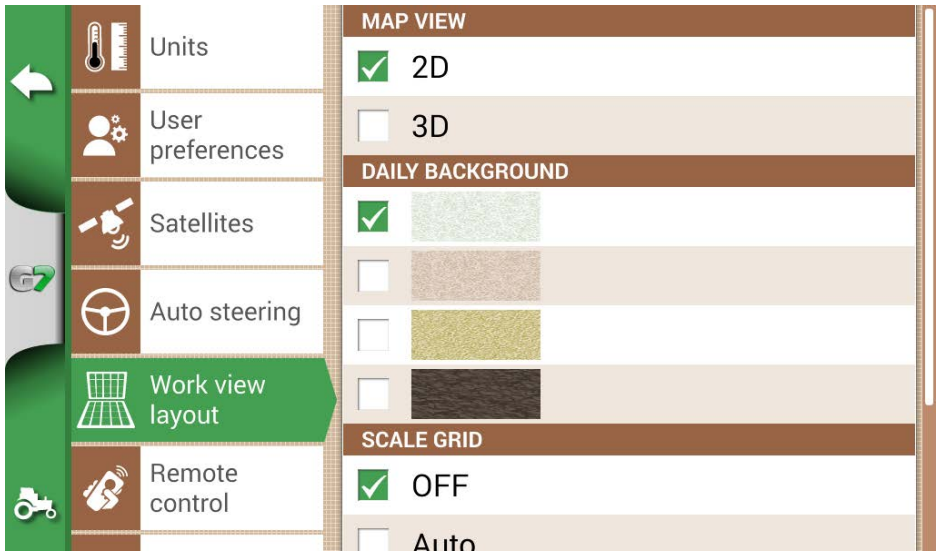


Figure 2.4.f Work view layout configuration page

2.4.7 Remote control (for G7 Plus only)

Remote control menu allows you to configure the supplied remote control.

1. Select "SETTINGS" > "Remote control"

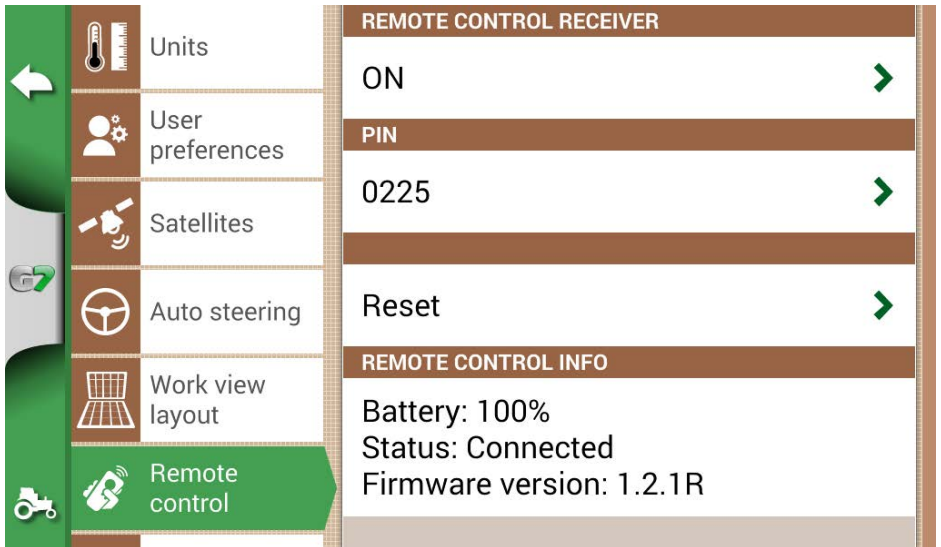


Figure 2.4.g Remote control setting page

Remote control allows you to have a quick access to the main functions, such as opening the main menu,

starting or pausing jobs, enabling or disabling Auto-Steering system, placing a mark on the map (on obstacles, on specific points, etc.).

To connect the remote control, make sure that it is within a range of a few metres from G7 Farmnavigator and insert batteries into the slot. Then:

1. Select "SETUP" > Remote control;
2. Select "REMOTE CONTROL RECEIVER" and Press "ON" to turn it on;
3. Select "PIN" and enter the PIN code given on the back of your remote control;

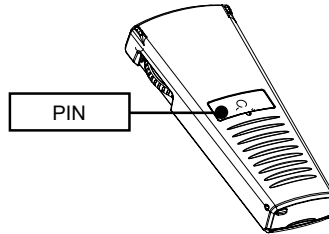
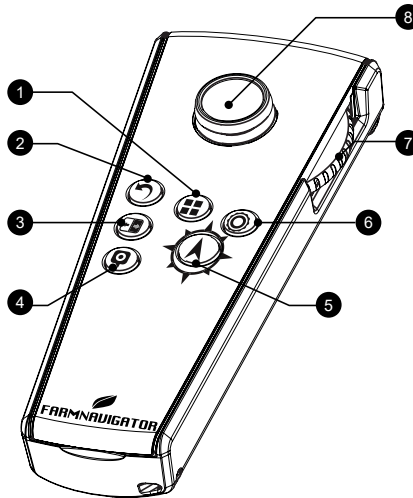


Figure 2.4.h Remote control

4. Press the middle button (navigation arrow) of your remote control, to connect the display to the remote control. Once connected, select "REMOTE CONTROL INFO" to check connection status, battery status and firmware version.

The functions of the remote control buttons can only be used in job page. On details:



<p>1</p>	<p>Menu Press it to open the main Menu.</p>	<p>2</p>	<p>Back Press it to go back to the previous page.</p>
<p>3</p>	<p>Cycle If the camera is connected, select it to open the camera visualization.</p>	<p>4</p>	<p>Mark Press it to mark an obstacle on the map.</p>

<p>5</p>	<p>Start/Stop Press it to start/stop colouring the worked area on the map.</p>	<p>6</p>	<p>Setting Press it to open set up page.</p>
<p>7</p>	<p>Zoom in/zoom out wheel Use the lateral wheel to zoom in or out the map.</p>	<p>8</p>	<p>Nudge control It allows you to move the line to follow, moving the remote control to the right or to the left.</p>

Table 2.4.i Remote control functions

2.4.8 Wireless connectivity (for G7 Plus only)

G7 Farmnavigator is provided with wireless connectivity and it can be connected to a WiFi hotspot. A dedicated menu allows the configuration of a WiFi network.

1. Select “SET UP” > “WiFi”;
2. Select “ON” to start searching for available networks;
3. Select the network that you want to access;
4. Select “Password” to enter the PIN code;
5. Wait for a moment and confirm the connection. Tap the name of the network to check connection status and IP address information.
6. Select “FORGET” to disable automatic WiFi connection.

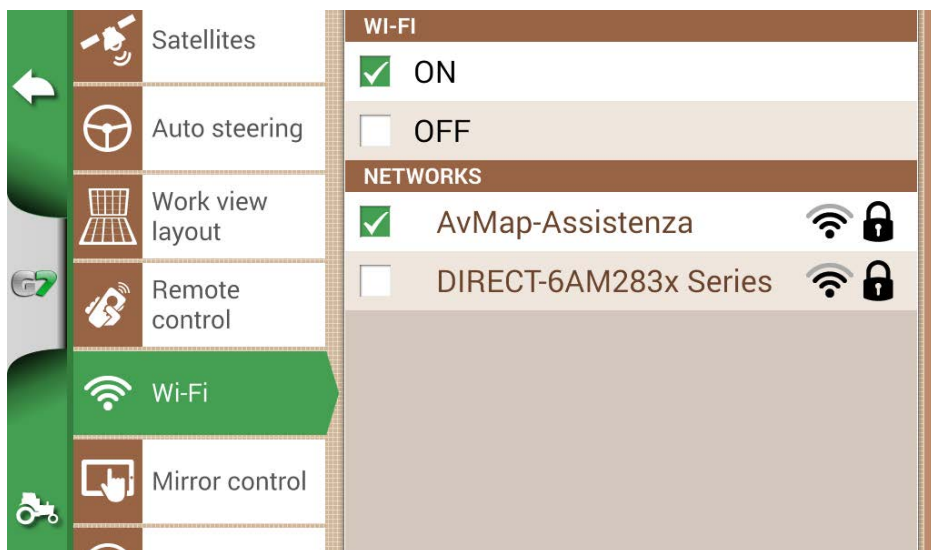


Figure 2.4.j WiFi configuration page

2.4.9 Mirror Control (for G7 Plus only)

Install the app Mirror Control to control G7 Farmnavigator with your smartphone or tablet. This app allows you to use the display of your Android or Apple device as if it was G7 Farmnavigator display.

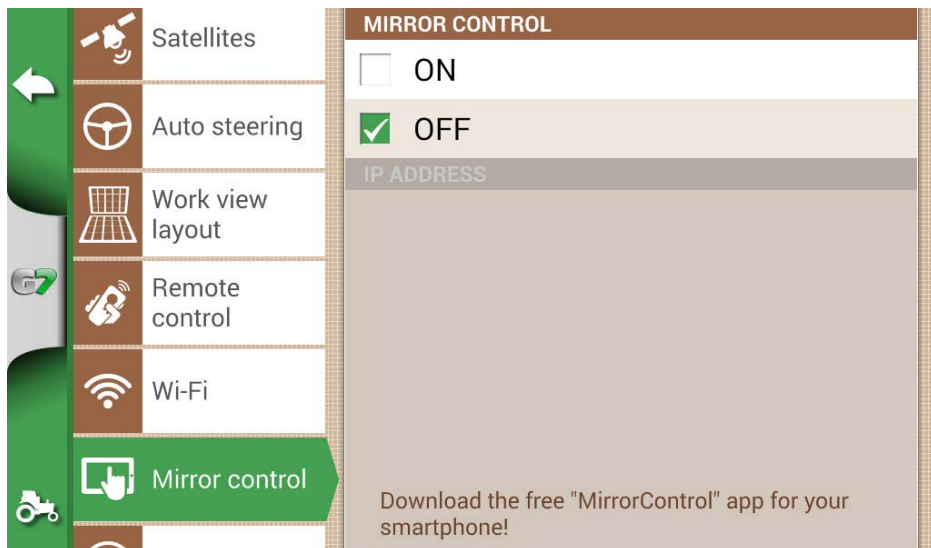


Figure 2.4.k Mirror Control configuration page

It is possible to connect G7 Farmnavigator to a smartphone or tablet via WiFi network, only if G7 Farmnavigator and the smartphone or tablet are connected to the same router.

1. Select "SETTINGS" > "Mirror-Control" > "ON";

2.4.10 System Information

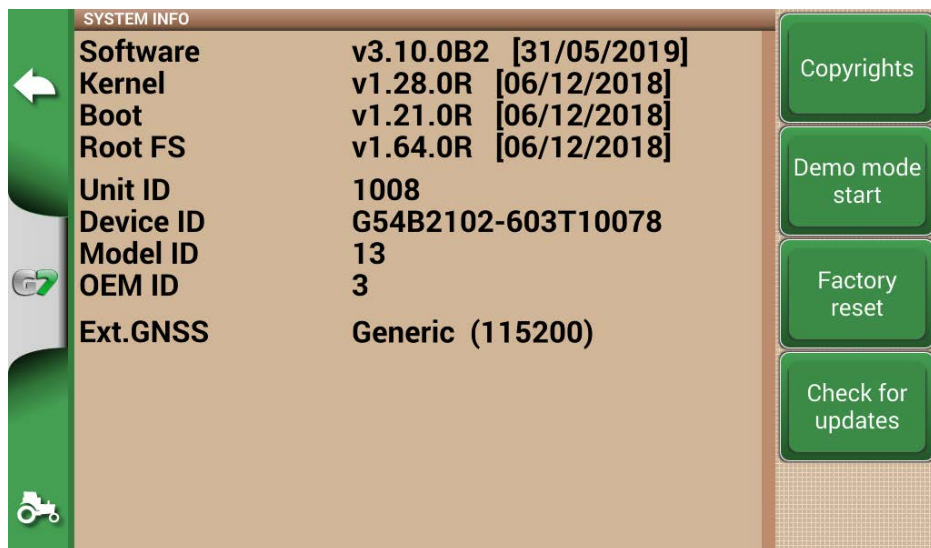


Figure 2.4.l System Info page

This page summarizes all the information about the device. On the right side of the page, there are

four buttons.

G7 Plus allows you to search for software updates automatically by selecting “Check for updates” button. In order to check for updates, you need to connect the device to a WiFi network.

1. Select “SETTINGS” > “System Info”

3. Job page

The Job page shows all the information and functions needed during your work activity.

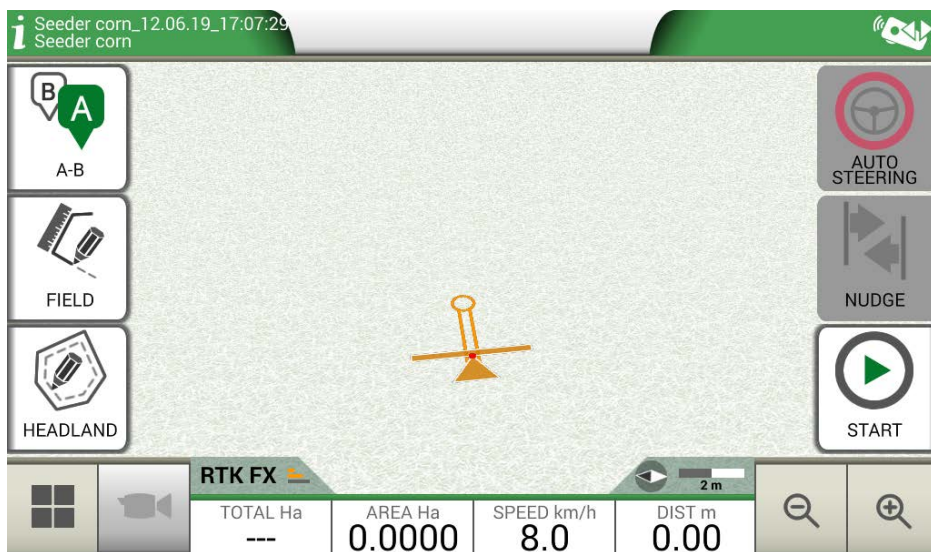


Figure 2.4.a Job main page

3.1 Current job information

3.1.1 Job name

Job and implement names appear at the upper left corner of the page. Touch "i" to directly access detailed information about your job.







 Diserbo 16.02.19_09:10:41 Botte diserbo	File and implement name description
---	-------------------------------------

Table 3.1.a Job name

3.1.2 Connected devices

At the upper right corner of the screen, there are the icons that identify the type of devices connected to G7 Farmnavigator.

   	Devices connected to G7 Farmnavigator
	Connected and working remote control




	Connected and working WiFi
	External third-party device connected and enabled for automatic sections control
	Auto-Steering system connected and enabled for the steering wheel control

Table 3.1.b Connected devices

3.1.3 Antenna precision and reception

At the bottom left corner of the page, it is possible to see the reception and precision status of the antenna connected to G7 Farmnavigator.


	Description of antenna reception status and signal quality
---	--

Figure 3.1.c Antenna reception and precision status

There are different levels of accuracy of the antenna:

RTK FX	Centimetre accuracy, maximum level of precision possible.
RTK FT	Decimetre accuracy, very high precision level. It does not fit for those jobs which require 1-2 centimetres precision.
DGPS	Sub-meter accuracy, middle level of accuracy, perfect for the majority of job. It includes the correction provided by geostationary satellites SBAS (EGNOS, WAAS, etc.).
3D/SPS	Low accuracy, it is not suitable for any type of job.
NO GPS	No GPS signal, the antenna is disconnected or it is in a place where there is a total coverage of the signal (inside a building).

Table 3.1.d Antenna precision level

If the antenna icon (Figure 3.1.c) is green in all its parts, the receiving conditions are perfect. Otherwise, wait a few minutes, clean the antenna and get the device away from metal obstacles or dense vegetation.

3.1.4 Zoom Level and compass

At the bottom right corner of the screen, it is possible to see both zoom level and the compass that indicates the direction of the tractor.


	The compass is oriented according to tractor's progress. The black tip of the compass indicates the North. The scale bar indicates the zoom level applied to the map.
---	---

Table 3.1.e Zoom and compass

3.1.5 Area, speed, distance

At the bottom of the screen, it is possible to see all the information about distance, speed, worked area and total area.

AREA Ha 0.0000	VELOC. km/h 3.2	DIST m 0.00	Information about area, speed and distance during work.
--------------------------	---------------------------	-----------------------	---

Table 3.1.a Area, speed, distance

The information displayed may vary if G7 Farmnavigator is connected to third-party devices. Long tap area value icon (second box starting from the left) to open a selection menu and change the information displayed.

3.2 Operative functions during job

3.2.1 Start/stop

START/STOP function enables you to draw or not a worked area.

- Press "START" to draw a green area of the same width as the implement and to count it in the worked area;
- Press "STOP" to interrupt colouring and suspend the counting of the area.

NOTE: START/STOP function can be also used in case of refuelling pauses during job.






	START Tap this icon to start working and colouring the worked area.
	STOP Tap this icon to interrupt colouring of the area.

Table 3.2.a Start/Stop functions

3.2.2 A-B lines

When you start a new job, tap A-B to have access to different types of guidelines. More specifically:

	A-B Parallel lines Tap this icon to work with A-B Parallel lines. Once you tap the icon, the point A will be saved. Proceed few metres straight ahead to save point B.
	A-B Contour guidelines Tap this icon to work with A-B Contour guidelines. Once you tap the icon, the point A will be saved. Proceed few metres straight ahead to save point B. It is essential to correctly set "Minimum Turning radius" in the implement settings page.
	Pivot Guidelines Tap this icon to work with pivot guidelines.




	<p>A-B Adaptive contour</p> <p>Tap this icon to work with A-B Adaptive contour. Once you tap the icon, the point A will be saved. Proceed few metres straight ahead to save point B.</p> <p>With this type of guideline, the last track drawn will be copied. It always provides a 180° turn at the end of the field.</p>
	<p>Point A + Direction</p> <p>Tap the icon to save point A. In the end, the direction of the tractor will be displayed and it can be confirmed or edit.</p>
	<p>A-B lines list</p> <p>This icon is active when the field is selected and if there are A-B guidelines already associated to that field.</p>

Table 3.2.b A-B line types

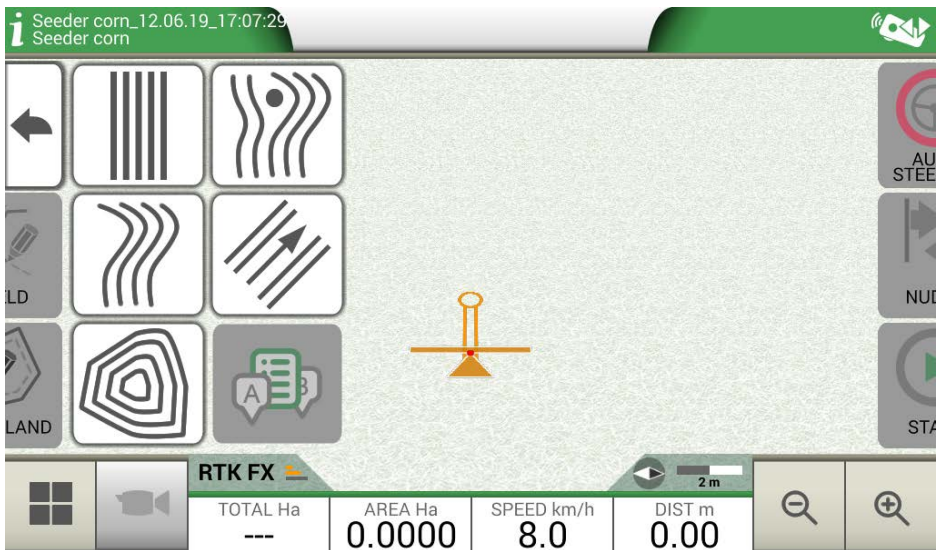


Figure 3.2.a A-B guidelines

Once A-B lines are defined and created, the icon will indicate the type of guideline which is currently active during your job.

	<p>A-B Parallel</p>		<p>A+ Heading</p>
---	---------------------	---	-------------------

Table 3.2.c Icon with A-B guideline type

During the job, tap A-B icon to access additional functions concerning A-B lines cancellation, change, or displacement.

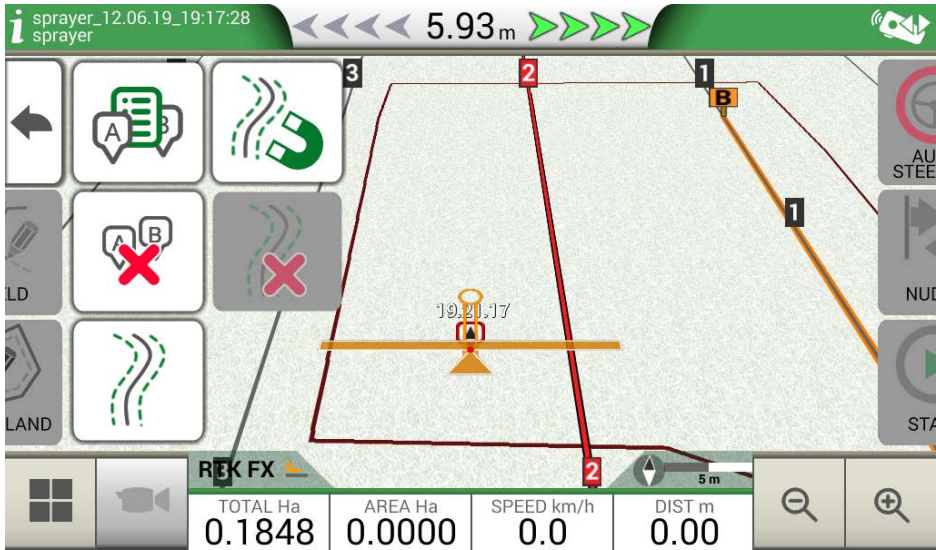


Figure 3.2.b Operating functions during job activity

Below is a list of all the functions available:






	<p>Magnet Move A-B lines according to the antenna position.</p>
	<p>Streets Move A-B guidelines some metres away from the antenna position. The maximum displacement permitted is equal to half of implement width.</p>
	<p>Shift cancellation Delete shift and reset original A-B guidelines.</p>
	<p>A-B guidelines list If active, it shows the list of A-B guidelines saved and used in the field.</p>
	<p>Delete A-B lines This feature allows you to delete the A-B guideline created in the field. The area already worked and coloured in green will not be deleted.</p>

Table 3.2.d Functions available in the A-B menu

3.2.3 Field

In order to define a field, go along the field perimeter and activate field registration mode.

The term field refers to the physical perimeter of the field. "FIELD" function allows you to save the position of the field. It is possible to carry on the activities even during the measurement of field boundaries. It is important to take into account that G7 Farmnavigator calculates the position of the field borders according to the width of the chosen implement.

- Move to the edge of the field;
- Select "START" if you are working the area during the registration of the field boundaries;
- Select "FIELD" and move along the field perimeters;

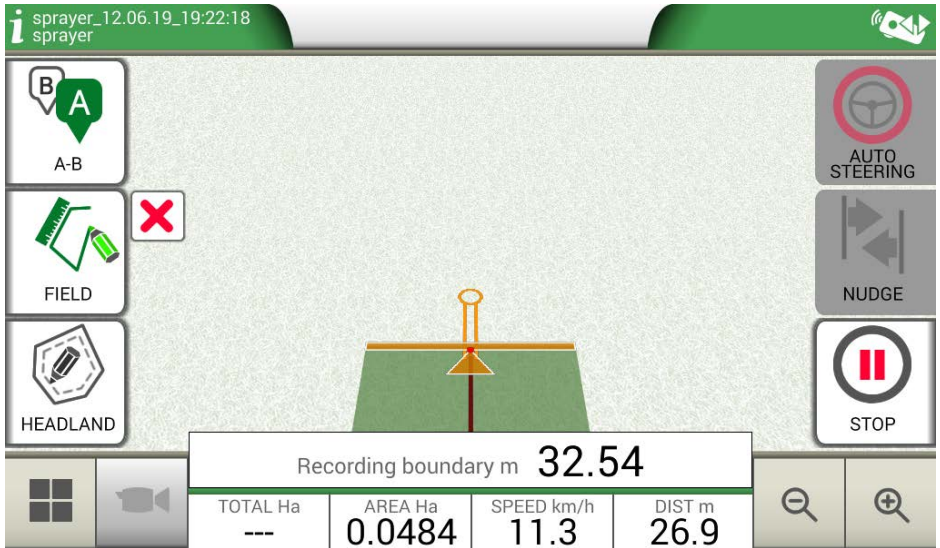


Figure 3.2.c Creation of a new field

- Tap "FIELD" again, when you are in close proximity to the starting point so as to finish recording;

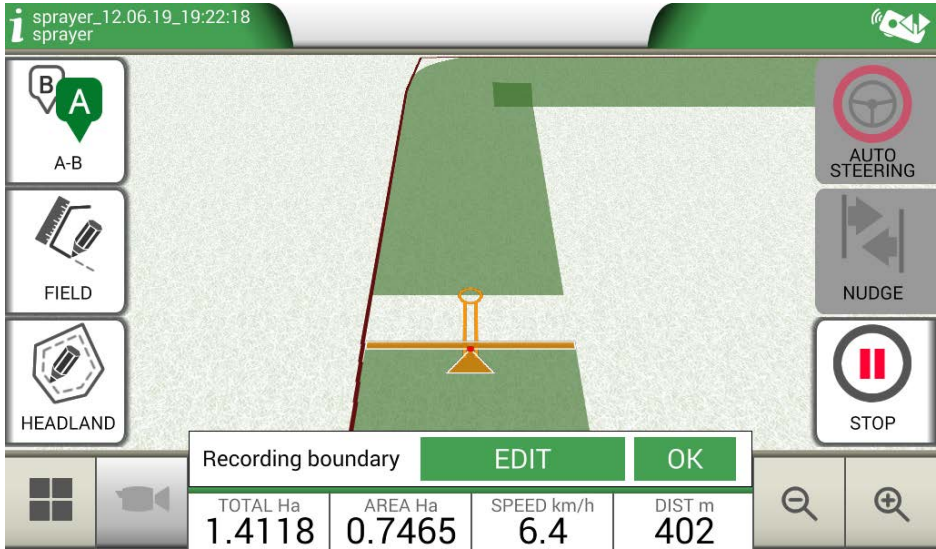


Figure 3.2.d Closing the field perimeter

- The field takes the same name defined during the new job creation page. Tap "EDIT" if you want to modify it;

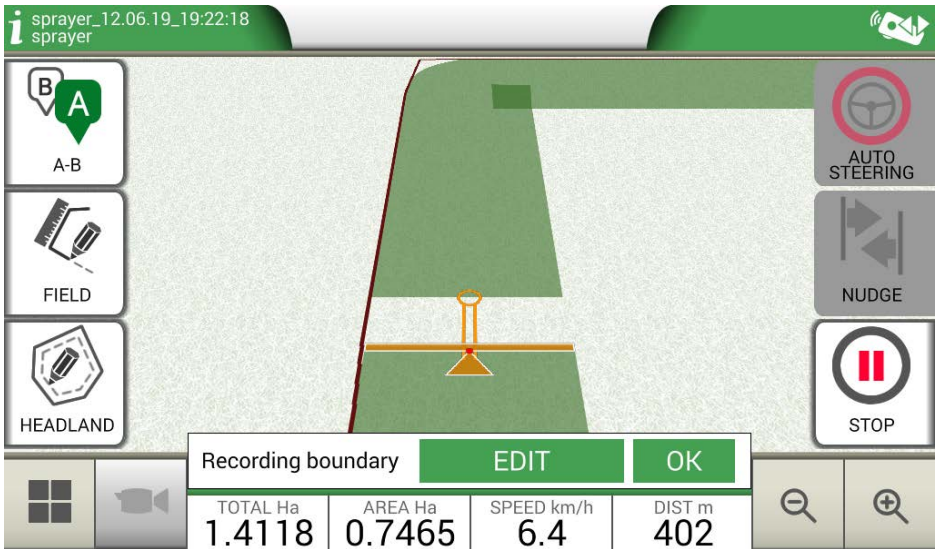


Figure 3.2.e Field name modification

- Field boundaries are now saved and stored in memory

NOTE: It is possible to locate the field on the same perimeters next year only by using an RTK instrumentation.

Once the field is defined, there are other features which allow you to visualize, edit or delete field boundaries. Tap "FIELD" to access these features:




	<p>Edit/continue field registration It allows you to modify field boundaries already defined by adding or modifying one of its part.</p>
	<p>Enable/disable field view Tap this icon to enable or disable the contour view of the field from the map.</p>
	<p>Delete field boundaries Delete field contour.</p>

Table 3.2.e Field functions detail

3.2.4 Headlands

This feature is very useful for determining the contour of the worked area. Define the field to use this function.

Take the following steps to activate headland:

- Select a field from the list and create a new job;
- Move to the edge of the field;

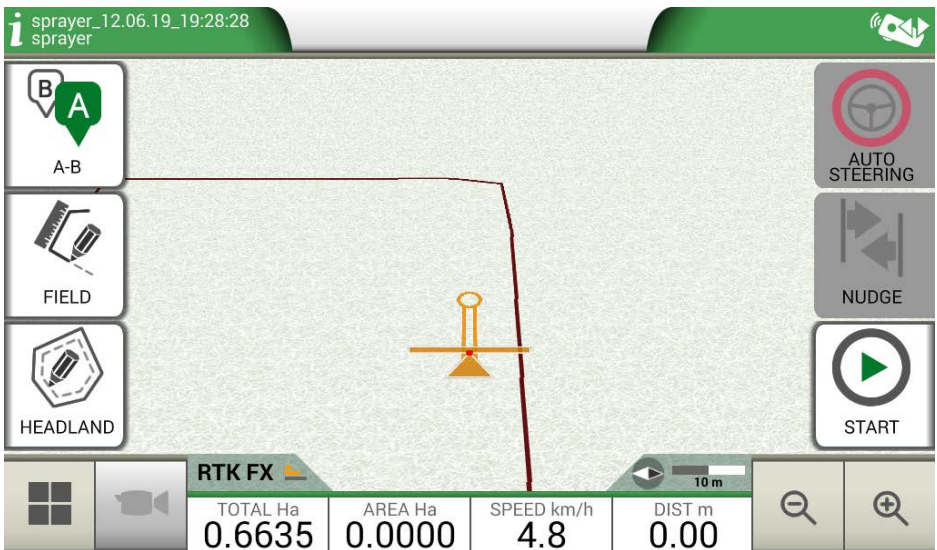


Figure 3.2.f Headland, start a new row

- Select headland key, named “HEADLAND”, and set the width of the headland that must be a multiple of implement width;
- An area which corresponds to the headland will be displayed on the map.

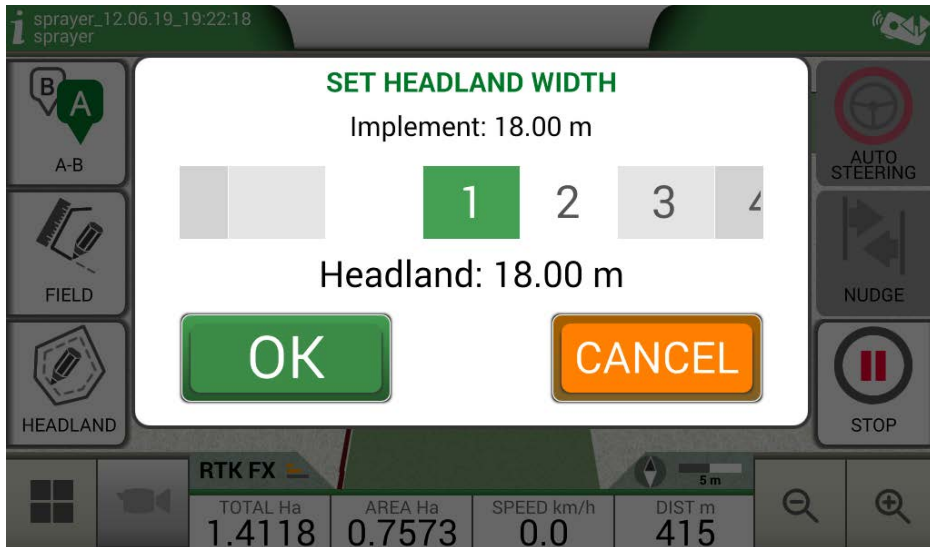


Figure 3.2.g, Headland width configuration

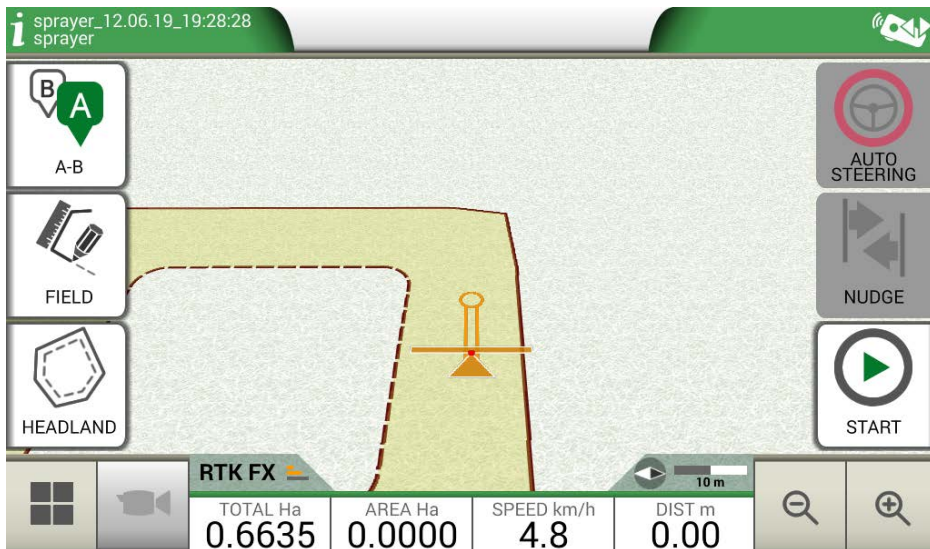


Figure 3.2.h Headland, area

Headland has different functionalities:

- It allows to define the area of the contour to be worked or already worked;

- In case of automatic sections control, it avoids that the product will be sprayed on the headland;
- It allows you to activate Auto-Steering system along the headland path (field contour).

Tap "HEADLAND" to enable all these functionalities. Four different icons will be displayed:





	<p>Headland active It allows you to open sections automatically on the headland. It shows the path tracking for Auto-Steering;</p>
	<p>Headland disabled It prevents the opening of the sections automatically inside the headland</p>
	<p>Headland inactive Headland is drawn on the screen, the opening of the sections is active and the path tracking for Auto-Steering is not active;</p>
	<p>Delete Headland Allows you to delete headland and to restore initial field conditions.</p>

Table 3.2.f Headland specific functions

3.2.5 Obstacles

G7 Farmnavigator allows users to save and view the position of a specific point on the map (e.g. an obstacle).

- G7 Plus permits you to activate this option only with remote controller.
- G7 Ezy is provided with a specific button on the main menu.

To save the position on a specific point:

- Tap on "MARK";


	<p>Obstacle / Mark If pressed, it saves the position and it draws a marker on the map</p>
---	--

Table 3.2.i Obstacle, point of interest

- On the map, it is possible to see a marker near the selected point.

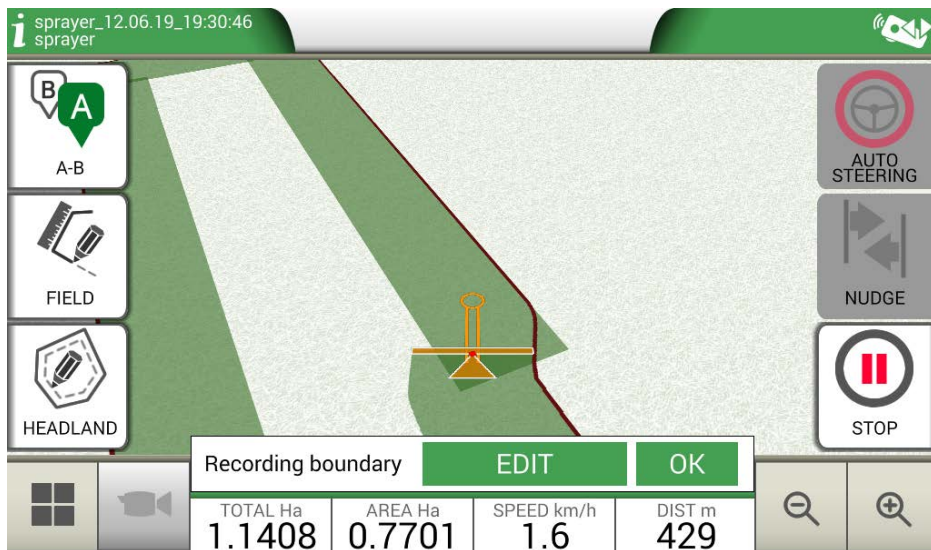


Figure 3.2.j Obstacle on the map

3.2.6 Auto-Steering system (For G7 Plus only)

G7 Farmnavigator is compatible with Auto-Steering mode. Connect G7 Farmnavigator to an external device which allows the steering wheel to be activated automatically and keep the tractor on the guideline.

In the Job page, the button marked as “AUTOMATIC STEERING” allows you to enable and disable automatic steering.




	<p>Automatic steering not available</p> <p>G7 Farmnavigator is enabled for Auto-Steering but steering device is not installed or it is not active.</p>
	<p>Auto-Steering active but not in use</p> <p>Touch the red button to enable Auto-Steering.</p>
	<p>Auto-Steering active and in use</p> <p>Touch the green button to disable Auto-Steering.</p>

Table 3.2.g. Auto-Steering buttons

For more detailed technical information about Auto-Steering system, check the Installation and Maintenance Manual.

3.2.7 Nudge

From the Job page, it is possible to move the A-B lines position a few centimetres. In order to do so, tap “NUDGE”.


	<p>Nudge It allows you to modify A-B line position.</p>
---	--

Table 3.2.k Work page, nudge button

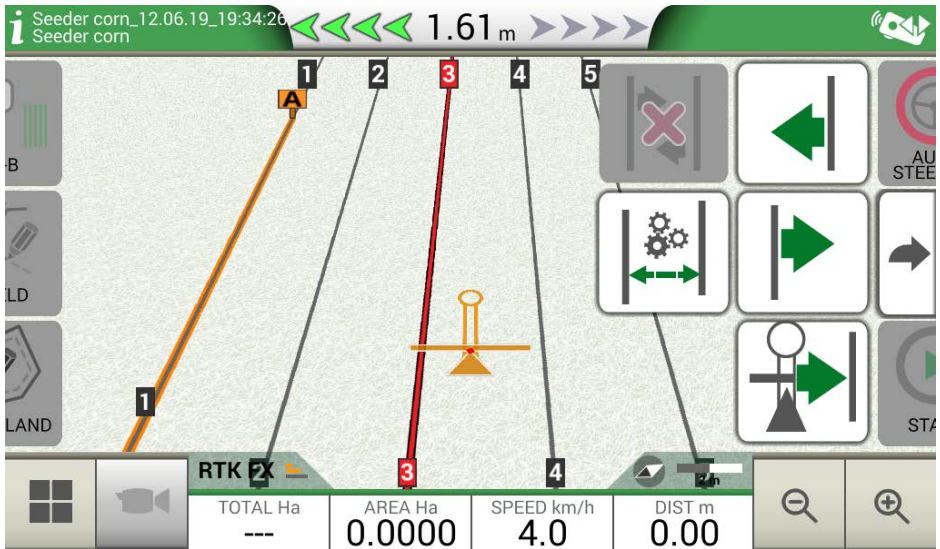





Figure 3.2.l Work page, A-B lines movement.

It is possible to insert nudge step, select movement direction or align the lines to the current position of the tractor.

	<p>Set nudge step Tap this icon to set nudge step in centimetres, e.g. 5 cm.</p>
	<p>Move the line to the left Tap this icon to immediately move the line to the left, for example 5 cm (value set as nudge step).</p>
	<p>Move the line to the right Tap this icon to immediately move the line to the right, for example 5 cm (this is the value set as nudge step).</p>




	<p>Align the lines Tap this icon to move the line on the current position of the tractor.</p>
	<p>Delete movement Tap this icon to restore A-B line initial position and remove all the saved movements.</p>
	<p>Go back to the previous page Tap this icon to close the menu relative to nudge page. The menu will be closed automatically after 5 seconds of inactivity.</p>

Table 3.2.m Details of nudge functions

ATTENTION: The maximum allowed nudge step is equal to half of the implement width.

4. Advanced operating modes

This chapter describes advanced operative functions.

4.1 Start new job, full mode

To start a new job in full mode, it is necessary to insert all the information required for a correct registration of a new job:

1. Select "START NEW JOB";
2. At "FARMER" line, tap the downward green arrow and select the farmer's name;
3. At "FIELD" line, tap the downward green arrow and select the field. In case of undefined field, tap on "Create New" and follow the procedure for inserting a new name;
4. At "IMPLEMENT" line, tap the downward green arrow and select implement's name;
5. At "DRIVER" line, tap the downward green arrow and select driver's name;
6. At "PRODUCTS" line, tap the downward green arrow and select the name of the product. It is possible to select more than just one product for every single job;
7. Select "OK" to go to work page;
8. Tap the "i" located at the upper left corner of the display to edit Job name:
 1. Tap the pen icon to modify the text;
 2. Select "OK";
 3. Tap on the downward green arrow to go back to the previous page;
 4. Tap on "A-B" to start the job.

4.2 Define the field and create new A-B guidelines

During the definition of the field, it is possible to create A-B guidelines to work the area inside the field boundaries. This procedure is to be used the first time you define the field.

In this way an A-B line is created in conjunction with the passage of the tractor on that side of the field, avoiding unnecessary overlaps.

- Create a new Job, preferably in full mode.
- Move to the edge of the field;

NOTE: It is advisable to change the name of the job. In order to do so, tap on "i" located at the top left corner of the display.

- Tap "START" if the area must be worked during the recording of the boundaries;
- Tap "FIELD" and move along the perimeters of the field;
- On the Job side, tap "A-B";
- Select the line type;
- Proceed straight ahead to save point B;
- Tap B and proceed straight ahead to close the contour;
- Tap "FIELD" to complete registration, when you are in proximity to the starting point;
- The field takes the name defined during the new job creation page. Tap "EDIT" if you want to modify it;
- Field boundaries will be saved and stored.

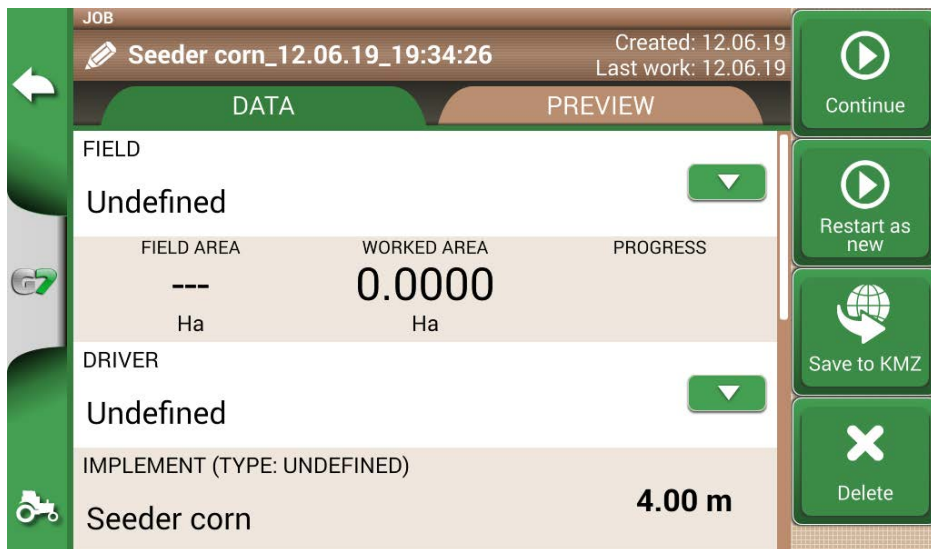


Figure 4.2.a Job name modification

NOTE: After one year, the replacement in the same position will be possible only with RTK instrumentation.

- It is possible to work within the perimeter following the defined A-B lines.

4.3 Working again on defined A-B lines using the same implement

This procedure allows you to avoid redefining A-B lines every year. For example; if you need to seed the same field with the same seeder every year.

NOTE: this feature is available only with RTK instrumentation.

G7 Farmnavigator allows you to reload a previous job and work it again, recalling the A-B lines used during the previous activity.

1. Tap "DATABASE";
2. Tap "FIELD";
3. Select farmer name;
4. Select field name;
5. Scroll to the "JOB" line and tap the downward green arrow;
6. Select the job that you want to recall;
7. Select "Start as new" to recall A-B lines saved during the previous activity.

In particular, there are two functions:

	<p>Continue The job will be reloaded and the coloration of the worked area will be maintained.</p>
--	---

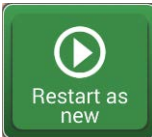
	<p>Restart as new</p> <p>This function offers you two possibilities:</p> <ul style="list-style-type: none"> - start from an existing job. - create a new job. It is advisable to modify job name tapping “i” at the upper left corner of the screen.
--	---

Table 4.3.b ‘Continue’ and ‘Start as new’ detail

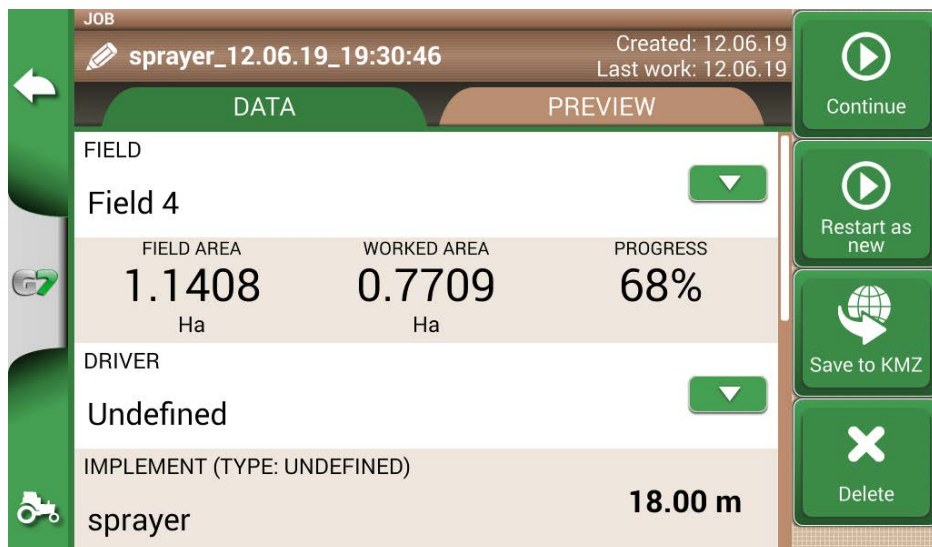


Figure 4.3.a ‘Restart as new’ function

4.4 Working on predefined A-B lines but with another implement

This procedure is useful to avoid redefining A-B lines every year. For example, if you have defined A-B guidelines during planting season and you need to recall them for your treatments next year.

The procedure is the following:

1. Tap “START NEW JOB”;
2. Select the “FARMER”;
3. Select the “FIELD”. It is essential to select the name of the field used during the previous activity, so that to recall the A-B lines used in that field.

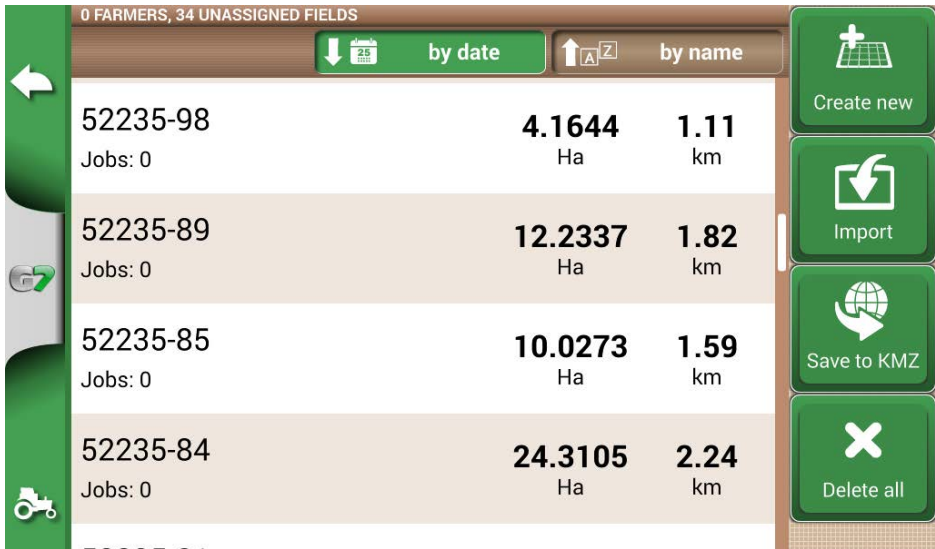


Figure 4.4.a Field selection page

4. Select the “IMPLEMENT” (it must be different from the implement used in the previous job);
5. Select the “DRIVER”;
6. Select the “PRODUCT”;
7. Tap “OK” to confirm the creation of a new job.

The last job will be reloaded and A-B lines width will be calculated according to the new implement width.

It is necessary to put the tractor in the same position as for the previous job, by following this procedure:

1. Tap on “A-B”;
2. Tap on “Magnet” icon. The first line will be move to the real implement position;
3. In case of error in the positioning, repeat the operation;
4. Select “START”;
5. Proceed with the activity.

4.5 Create more than one A-B line during the same job session

NOTE: this function can be used only if the field is set.

G7 Farmnavigator allows you to save more than one A-B lines and recall them for further activities. To save more than one A-B lines within the field, proceed as follows:

1. Create a new job, select a field from the list or create a new field;
2. Start the job and define an A-B line (e.g. A-B Parallel guidelines);
3. Tap again on “A-B” if you need to create another A-B line (e.g. adaptative guidelines);
4. Tap the “A-B” icon, marked with a red X, to cancel the lines from the display;
5. Tap “YES”. The line will be deleted only from the display, but it is stored in memory;
6. Move the tractor to the new job direction, inside the same field and the same job;

7. Tap “A-B” icon and select the lines type that must be defined (e.g. Contour guidelines);
8. Move to the point B;
9. At this point, a second A-B line is created.

4.6 Change A-B lines during the same job

ATTENTION: this function can be used only if the field is set.

If during your activity, there is a need to change A-B lines, proceed as follows:

1. Tap “A-B”;
2. Tap AB List icon.

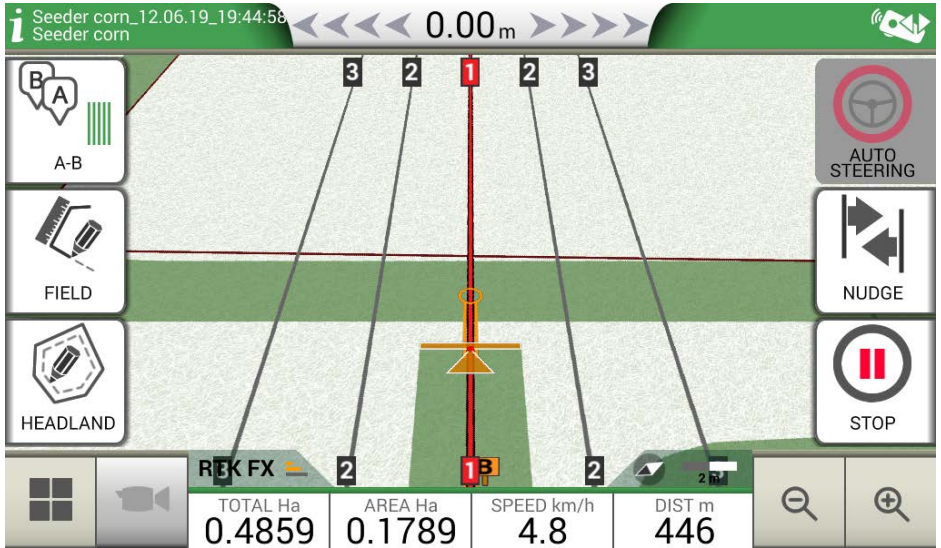


Figure 4.6.a A-B line change during job

	<p>AB list icon.</p>
---	----------------------

Table 4.6.b A-B list icon

3. Select the A-B line type that you need to display;

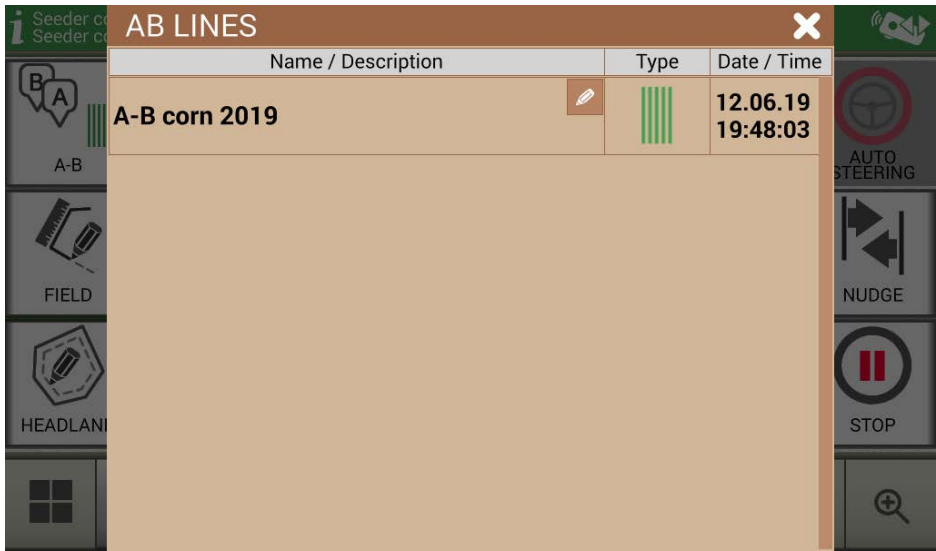


Figure 4.6.c List of A-B lines used in a field

4. Delete A-B line, tap “YES”. The line will be deleted only from the display, but it is stored in memory;

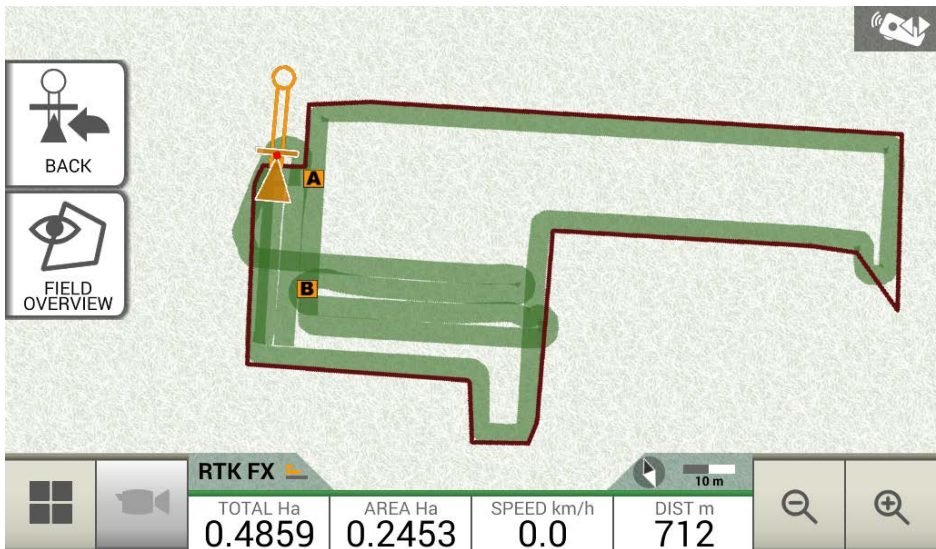


Figure 4.6.d Example of a job with more than one A-B line saved

4.7 Move the line to a specific point, “Magnet” function

It is possible to use “Magnet” function to:

- Avoid an obstacle (moat, drain, street) and move to a new parcel of field without creating a

- new A-B line;
- Locate the line on your current position, maintaining A-B direction;
- Reuse A-B lines with an implement which has a different width: locate the implement at the starting point, use the "Magnet" function to move the origin of A-B lines on that point.

To use "Magnet" function:

1. Tap "A-B";
2. Tap "Magnet";

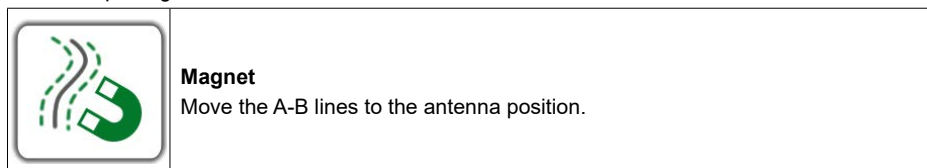


Table 4.7.a "Magnet" function

3. A-B lines will be moved to the exact position of the tractor.

4.8 Move A-B line according a precise value, "Street" function

"Street" function allows you to move A-B line according to a precise metrical distance. The repositioning of the A-B lines starts from the tractor current position.

This function is essential when you need to:

- Leave a precise distance between one A-B line and the other;
- Create "Streets" in sowing area, usually used for irrigation;
- Split the parcel into precise portions.

In order to use "Streets" function:

1. Tap "A-B";
2. Tap on "Street" icon;

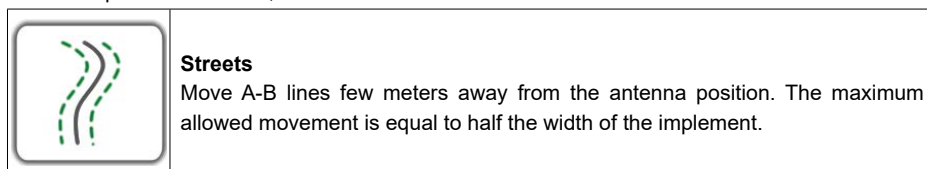


Table 4.8.a 'Streets' Functions

3. Set the metrical distance according to which the row will be moved;

NOTE: the distance will be calculated starting from the antenna position (which corresponds to the position of the tractor);

4. Confirm to apply the movement.

4.9 Connect an external device to control sections

G7 Farmnavigator allows you to connect third-party external devices to make an automatic control of the section. This feature can be used with implements such as:

- Weeding barrel
- Spreaders
- Planters

In the appendix, there is a list of supported devices.

The procedure to be performed for the correct configuration is as follows:

1. Connect the external device to the G7 Farmnavigator bracket through 9-pin serial port marked as "CONTROLLER";
2. Turn both G7 Farmnavigator and the external device on. Any other settings concerning the external device are not part of this manual;
3. Select "DATABASE" > "IMPLEMENTS";
4. Create a new implement;



Figure 4.9.a New implement page

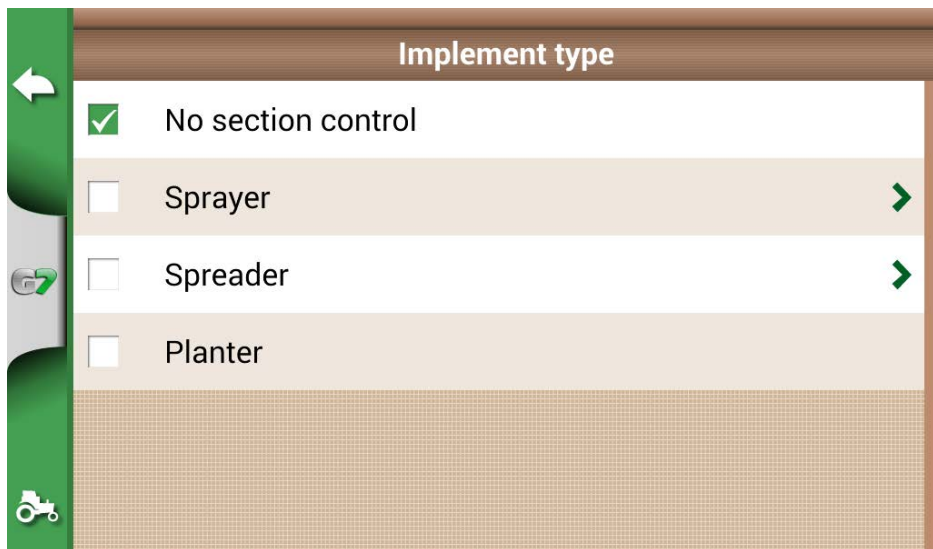


Figure 4.9.b External implement type selection page

5. Select which type of external control is connected to G7 Farmnavigator;
6. Scroll through the list and select the connected device;

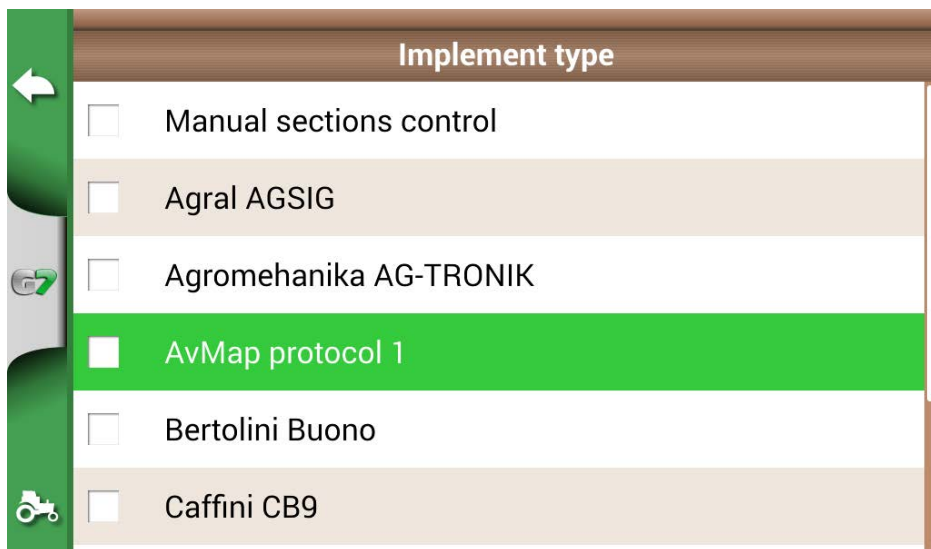


Figure 4.9.c External device type

7. Wait for a connection between G7 Farmnavigator and the device;

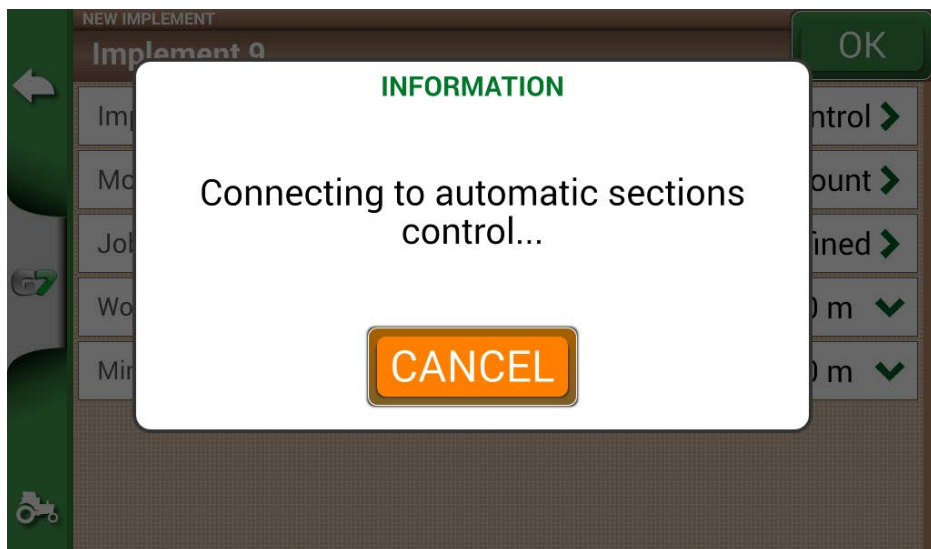


Figure 4.9.d Connection between G7 Farmnavigator and the external device

8. Set the total width divided into sections;

NEW IMPLEMENT

Implement 9 OK

Implement type Manual sections control >

Set nozzles per section Set sections width

Total width: 21.00 m

1	2	3	4	5	6	7
3.00	3.00	3.00	3.00	3.00	3.00	3.00
6	6	6	6	6	6	6

Mount type and offset Rear fix mount >

Figure 4.9.e Section configuration: nozzle per section

9. It is possible to set the width of the spray boom either for the number of nozzles per single section or for the entire section width;

NEW IMPLEMENT

Implement 9 OK

Implement type Manual sections control >

Set nozzles per section Set sections width

Total width: 21.00 m

1	2	3	4	5	6	7
3.00	3.00	3.00	3.00	3.00	3.00	3.00

Mount type and offset Rear fix mount >

Figure 4.9.f Sections configuration: section width

10. Enter the number of boom sections;

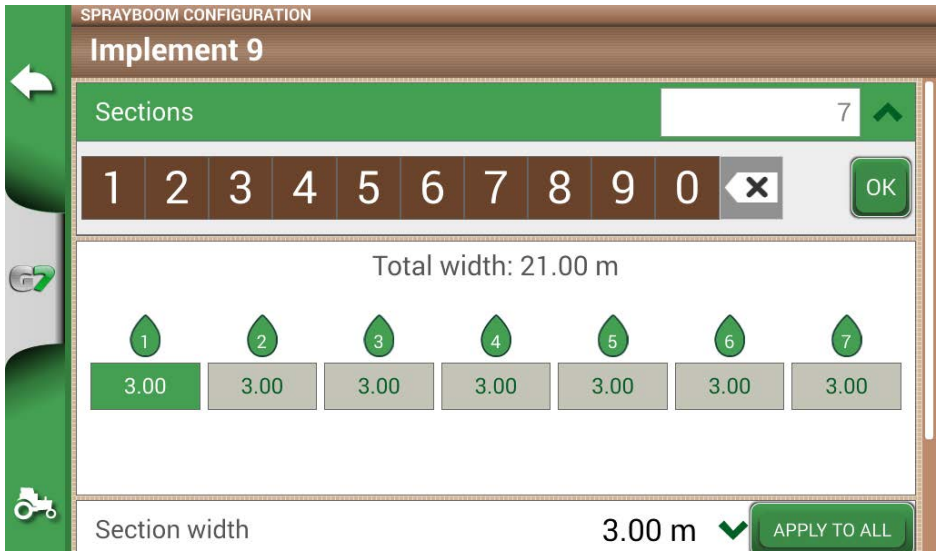


Figure 4.9.g. Number of sections configuration

11. Insert the individual width of each section. Check the total width to avoid errors;

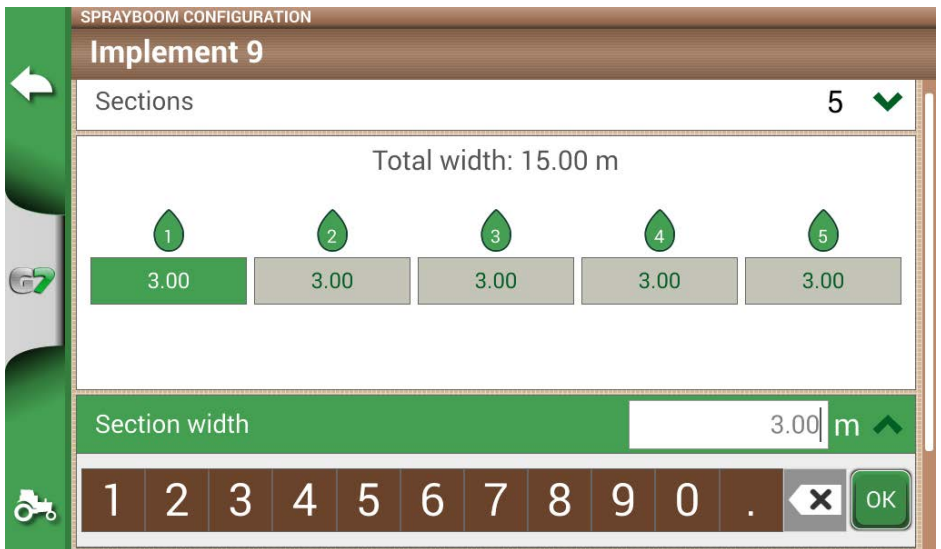


Figure 4.9.h Single section width configuration

Below is an example of 18 metres boom with 5 sections;

G7 Farmnavigator allows you to insert a time value to advance the opening and closing of the section so as to anticipate the command that must be send to the external device. This value, expressed in seconds, is equal to the time required by the device to order the opening of the sections and the actual release of product from the nozzles.

SPRAYBOOM CONFIGURATION

Implement 9

Sections 5 ✓

Total width: 18.00 m

1	2	3	4	5
4.00	4.00	2.00	4.00	4.00

Section width 2.00 m ✓ APPLY TO ALL

Section ON delay 1.0 s ✓

Section OFF delay 1.0 s ✓

Figure 4.9.i Example of 18 meters bar with 5 sections

SPRAYBOOM CONFIGURATION

Implement 9

Total width: 18.00 m

1	2	3	4	5
4.00	4.00	2.00	4.00	4.00

Section width 2.00 m ✓ APPLY TO ALL

Section ON delay 1.0 s ✓

Section OFF delay 1.0 s ✓

Figure 4.9.j Configuration of opening and closing delays of the section

There are other settings, among which the spray boom overlap percentage.

For example, a value of 100% means that the section will be closed in case of total overlapping. A value of 50% means that the section will be closed when the boom overlaps the total section width by 50%.

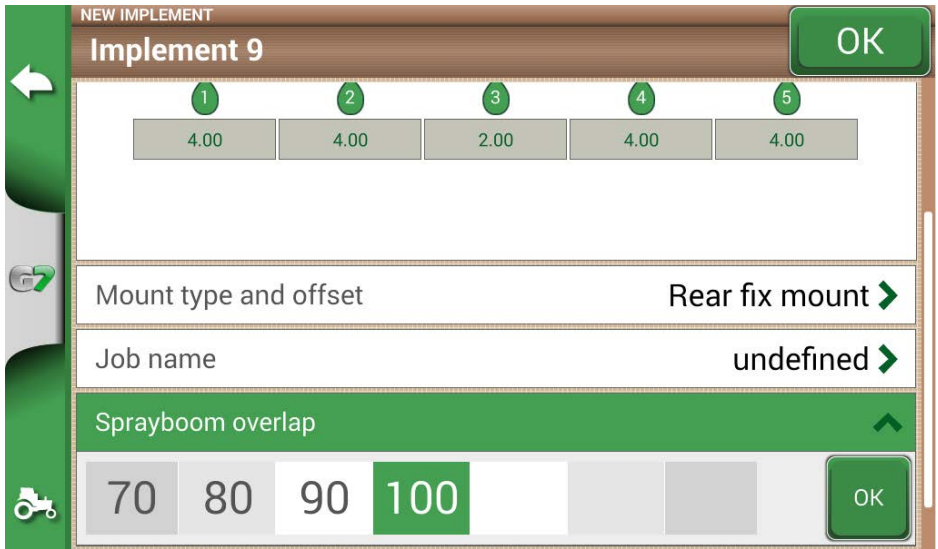


Figure 4.9.k Spray boom overlap configuration

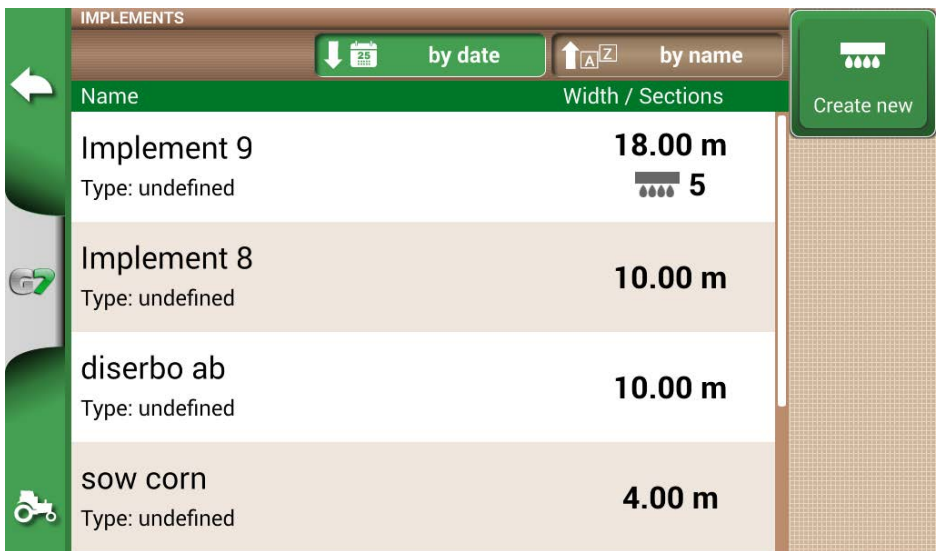


Figure 4.9.l Implements with automatic section control

The implement is now set and displayed in the implement list. An icon identifies the implement with active section control. On the job page, there are icons that show the sections status.

	<p>Boom sections status</p> <p>Green colour indicates that the section is active and operating.</p> <p>Red colour indicates that the section is active but turned off.</p>
--	---

Table 4.9.m Boom sections status

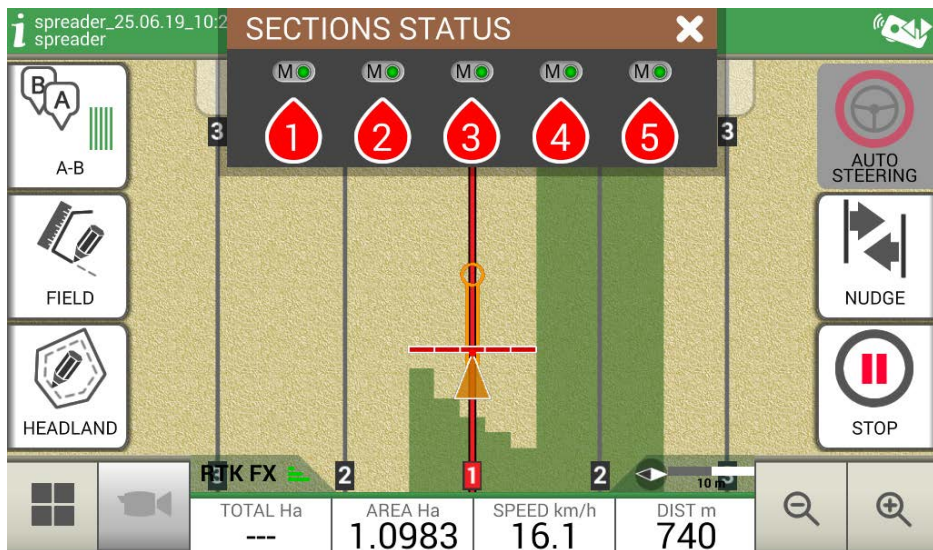


Figure 4.9.n Boom sections status

G7 Farmnavigator allows you to manually control a section, by tapping the boom sections status.

It is possible to control a section manually forcing the automatic section control. Manual section control can be configured to either be always active or inactive.

	<p>Automatic Status The section will be turn on and off automatically.</p>
	<p>Manual status active The section is always active. In this case, the drop is green.</p>
	<p>Manual status inactive The section is always inactive. In this case, the drop is red.</p>

Table 4.9.o Section status: automatic and manual

4.10 Using “Planter” to create fields planting layout

G7 Farmnavigator allows you to design and realize planting layout of vines, fruit plants, cultivation and installation of poles.

In order to activate this feature, it is necessary to use “Planter”. On details:

1. Tap “SETTINGS” > “IMPLEMENTS”;
2. Create a new implement and insert the name;

3. In the implement type selection menu, select "Planter";

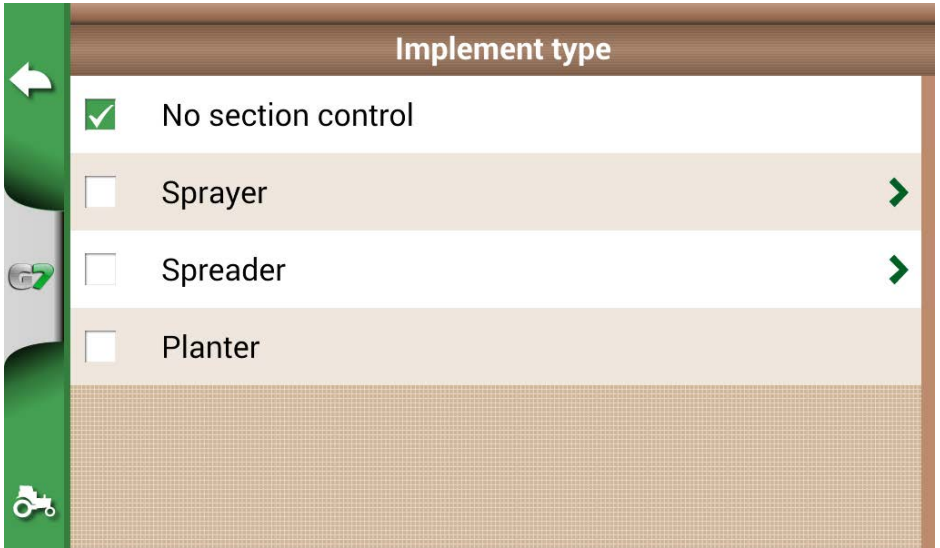


Figure 4.10.a New implement: planter

4. Create a new job and select A-B parallel lines (or A + Direction). Point A will represent the position of the first plant;
5. Define the distance between rows and plants and tap OK to confirm;

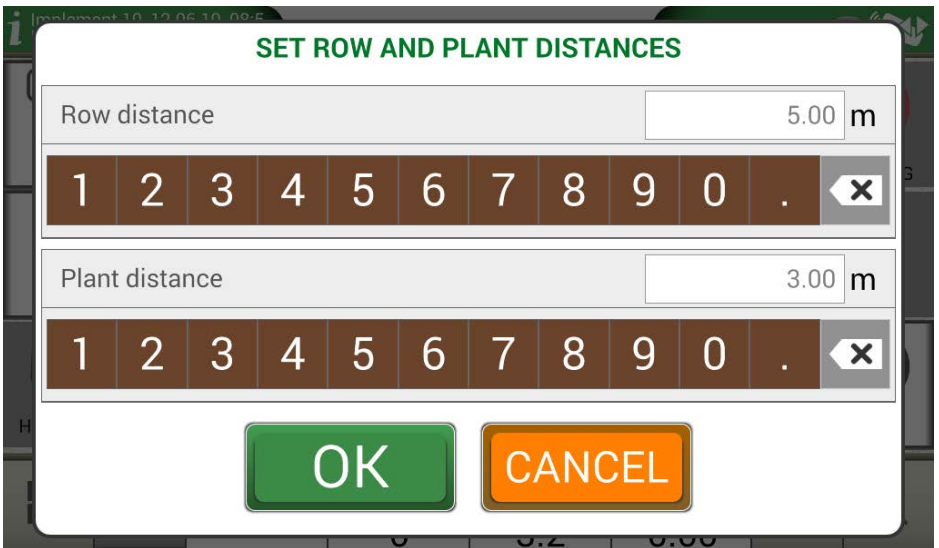


Figure 4.10.b Distance between plants and rows configuration page

6. The position of point A and the position of the first plant are defined;

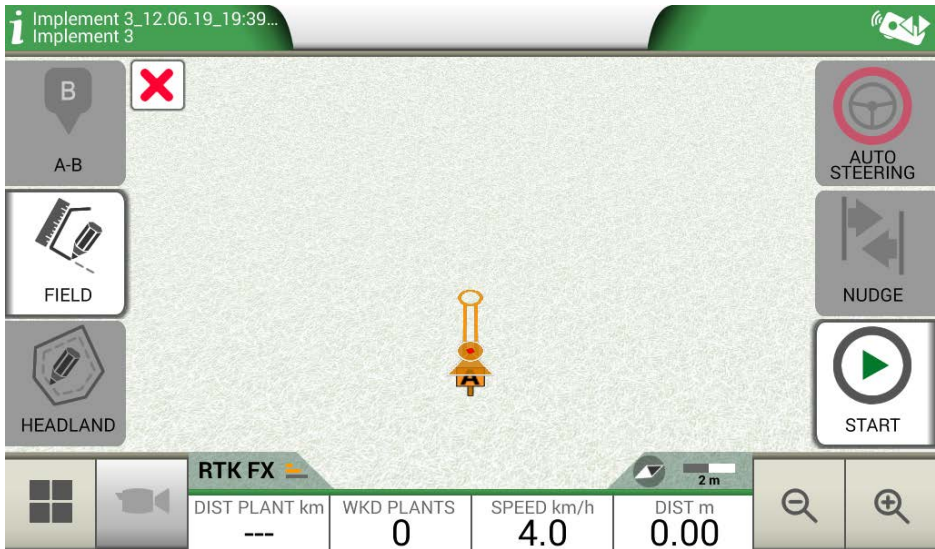


Figure 4.10.c Field planting layout, point A

7. Proceed to point B and tap "B". In this way the lines will be created and the plants position will be marked on the line.

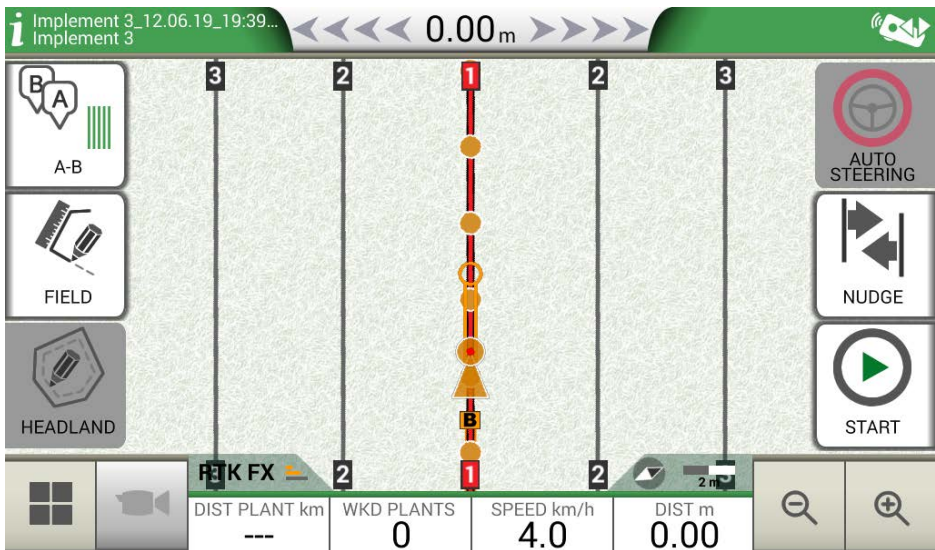


Figure 4.10.d Plant distribution on A-B line

8. When the position of the antenna coincides with the position of the plant, the circle will change its colour from orange to green;

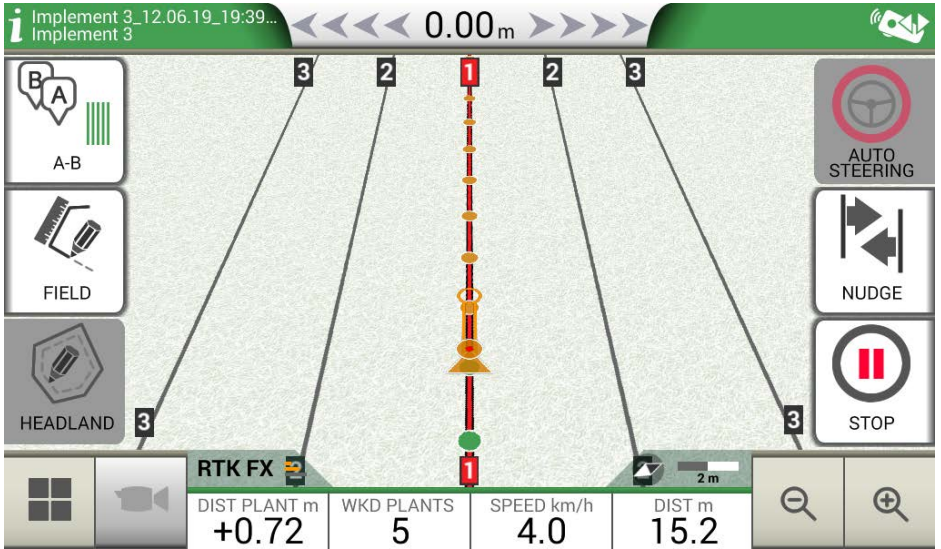


Figure 4.10.e Plants worked in field planting layout

9. Further information are displayed at the bottom of job page;

<div style="border: 1px solid black; padding: 5px; text-align: center;"> DIST PIANT m +0.10 </div>	<p>Distance from the plant</p> <p>This information allows user to know the exact distance between the antenna position and the next plant (if the sign is positive) or the distance from the previous plants (if the sign is negative).</p>
<div style="border: 1px solid black; padding: 5px; text-align: center;"> PIANT LAV 27 </div>	<p>Number of worked plants</p> <p>It allows user to know how many plants have actually been worked from the beginning of the work.</p>

Table 4.10.f Information about "Planter"

NOTE: third-party accessories will be available for the motions of the tractor, both for Auto-Steering and for planter automation.

5. Importing and exporting data

5.1 Download a job and view it in the office

G7 Farmnavigator allows you to download a job in KMZ format and visualize it on your Personal Computer (PC).

NOTE: in order to use this function, Google Earth™ software must be installed on your PC.

To download the file, you need an USB stick, 'USB cable + Video in' (G7 Ezy, P/N: K2CYFS0600) or the 'USB cable + Video in + Ethernet' (G7 Plus, P/N: K2CYFS1000).

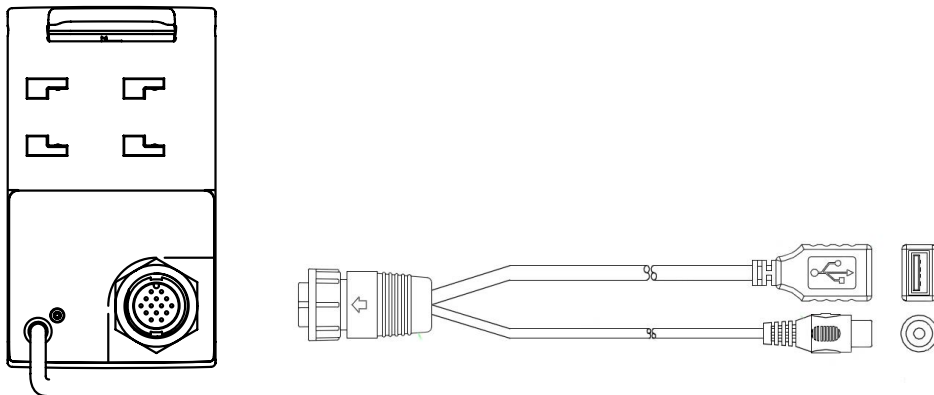


Figure 5.1.a USB Cable + Video in

1. Connect USB cable to the G7 Farmnavigator bracket;
2. Insert USB stick in the supplied USB cable connector;
3. Tap "DATABASE" > "JOBS";
4. Select the job you want to export.

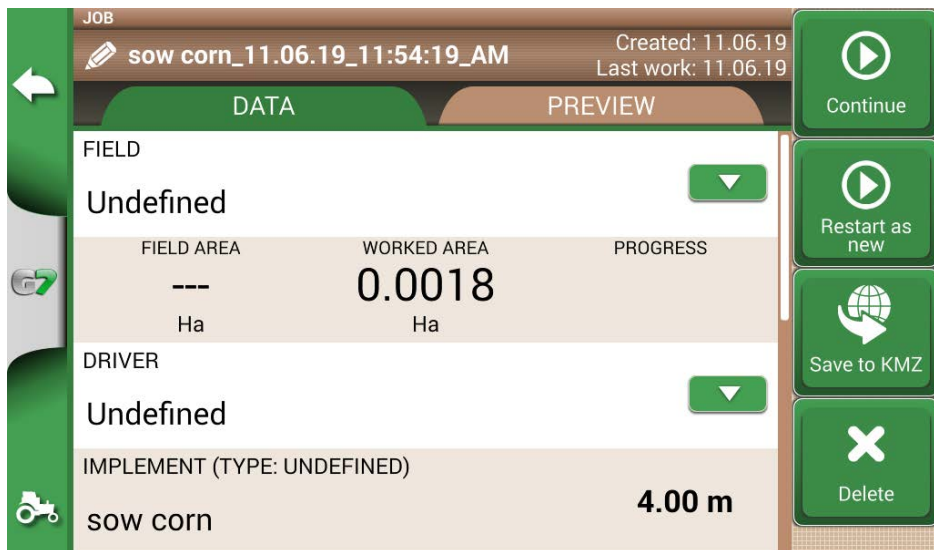


Figure 5.1.b Saving data in KMZ

1. The file will be automatically saved in the USB stick;
2. Connect the USB stick to your PC;
3. Enter the "Export" folder to access the saved job;
4. Double click on the job name;
5. Google Earth™ will be opened (if previously installed).

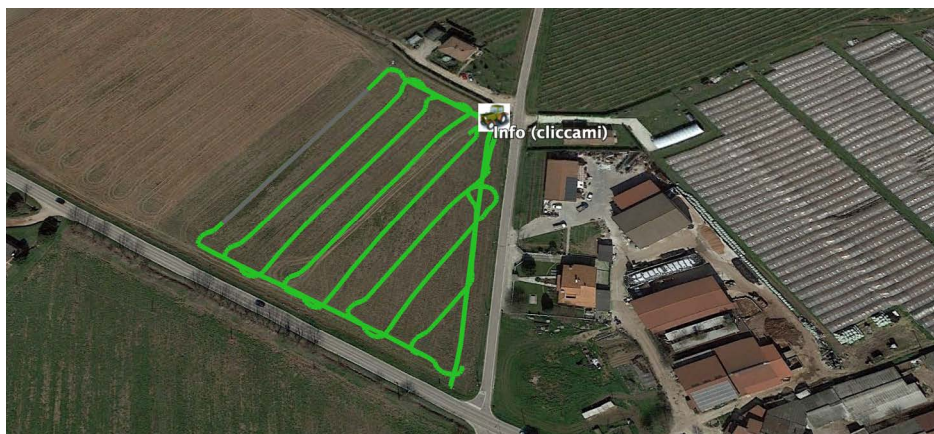


Figure 5.1.c Job view with Google Earth™

Tap "Info" to see all job information available.

5.2 Import the field boundaries in KMZ format

G7 Farmnavigator allows you to import field boundaries in KMZ format. This feature is useful when you want to move field registration from one G7 Farmnavigator to another or if the field boundaries

are drawn in your office using Google Heart™ software.

Create a new folder called "Import" and put it in the USB stick. Inside the folder "Import", copy the KMZ files you want to import. Connect the USB stick to G7 Farmnavigator using the supplied cable.

1. Tap "DATABASE" > "FIELD"> "Import";
2. Select the file that you need to import;



Figure 5.2.a KMZ file import access menu

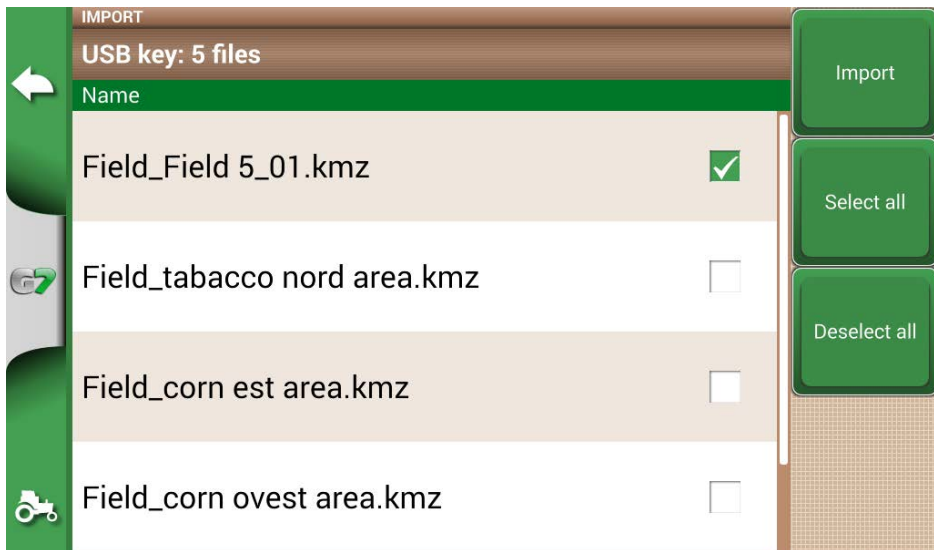


Figure 5.2.b File KMZ selection

- Tap "Import" and wait for the fields to be imported;

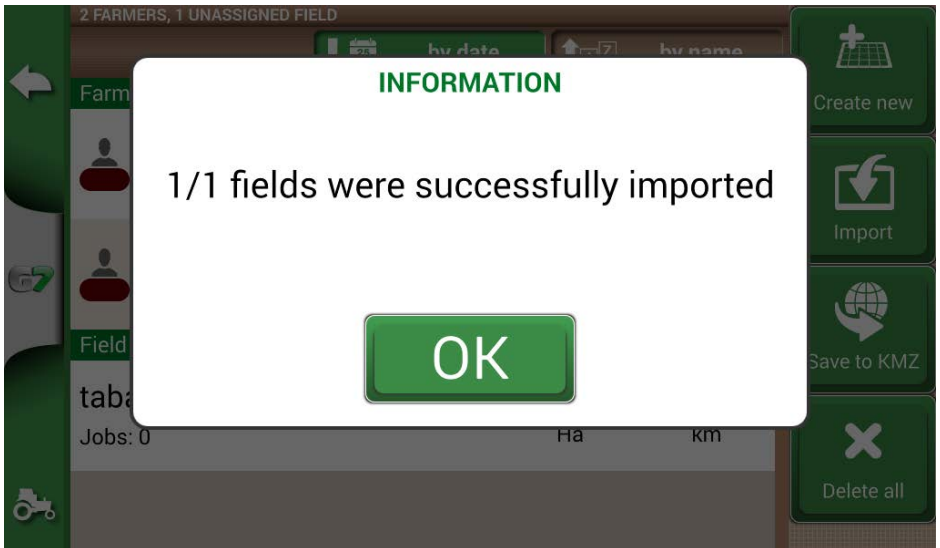


Figure 5.2.c Importing fields from KMZ

- In "FIELD" menu, there is a field for each imported KMZ file.

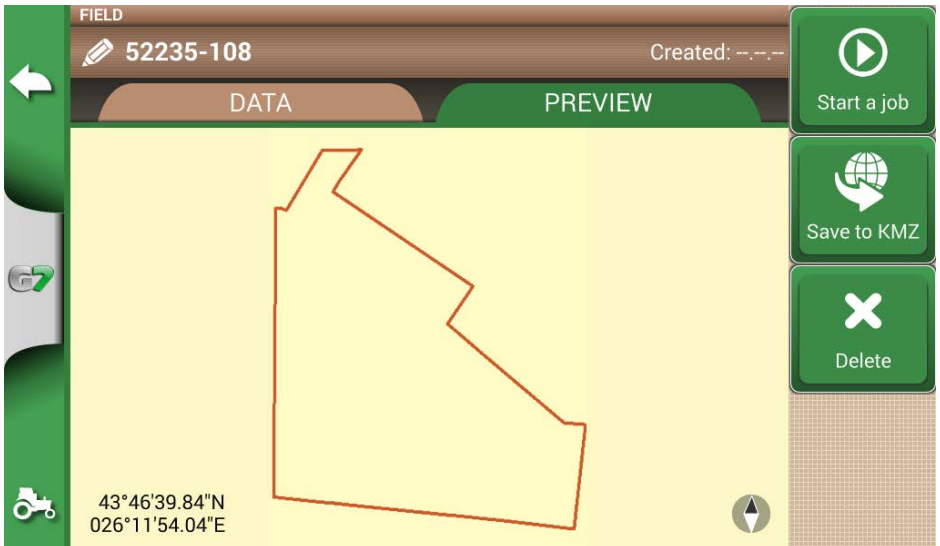


Figure 5.2.d Preview of a field imported from KMZ

5.3 Importing a map in SHP file format

Create a new folder called "Import" and put it in the USB stick. Inside the folder "Import", copy the

KMZ files you want to import. Connect the USB stick to your G7 Farmnavigator using the cable supplied.

- Tap "DATABASE" > "CAMPI" > "Import";



Figure 5.3.a File SHP import menu

- Select the file which you need to import;

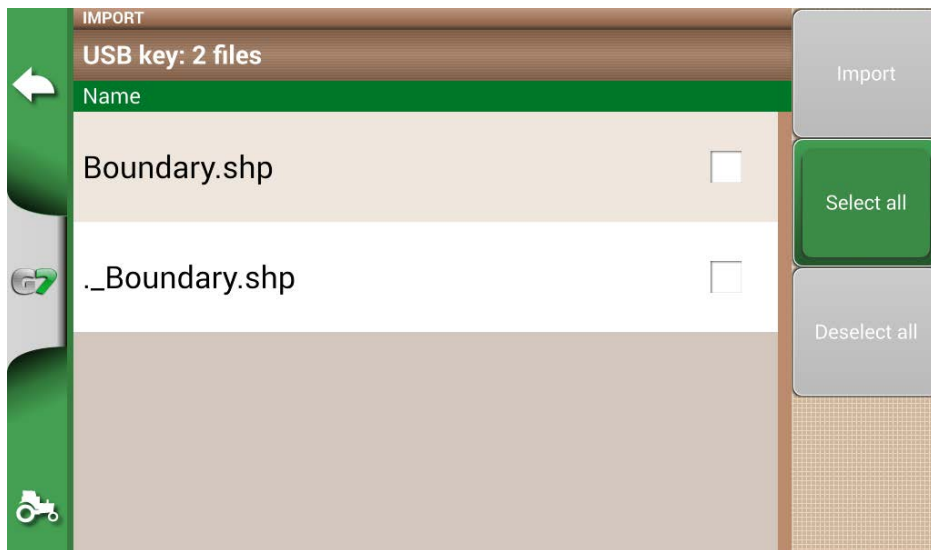


Figure 5.3.b SHP file Import

- Tap "Import" and wait for boundaries to be imported;

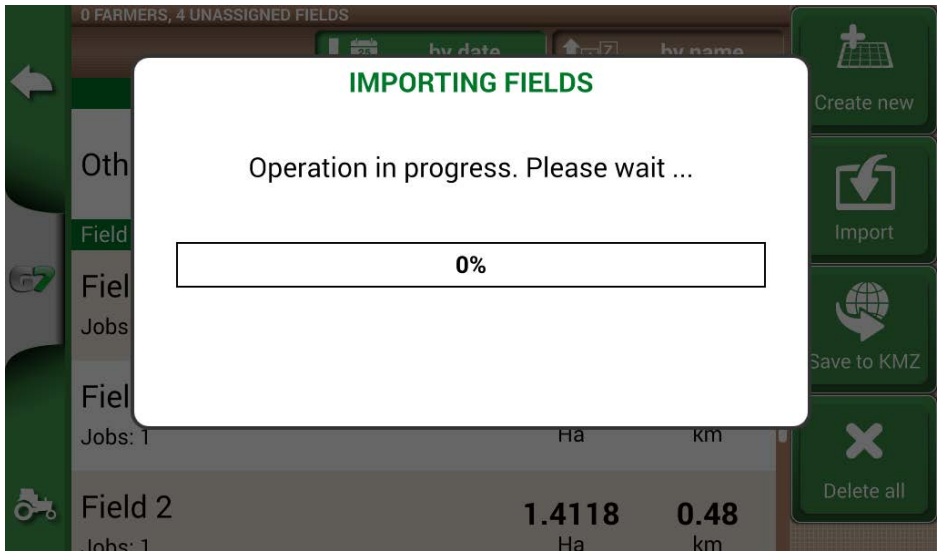


Figure 5.3.c Import SHP file – work in progress

- All the field boundaries contained in the SHP file are now visible in “FIELD” menu;

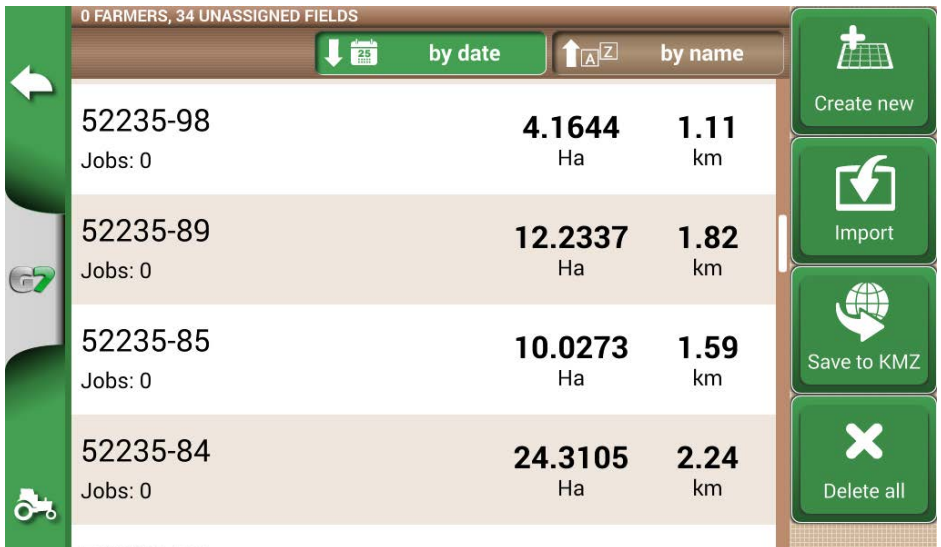


Figure 5.3.d – List of fields loaded from SHP file

- It is now possible to see a preview of each field;

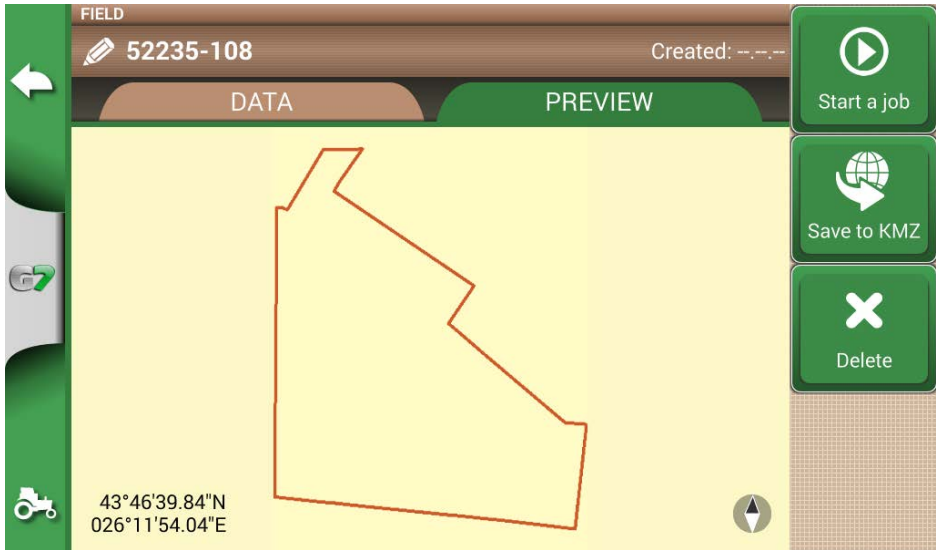


Figure 5.3.e Example of a field loaded from SHP file

5.3.1 Create a boundary in SHP file format

There are various software available for creating boundaries and exporting them to SHP file format. Above is an example of saving field boundaries in SHP format starting from Google Earth™.

- Drawn a polygon in Google Earth™



Figure 5.3.f Example of a polygon drawn with Google Earth™

- Save the file with "Save place as..";

- Use one of the online software available to convert a KMZ file into a SHP format (for example; MyGeodata Cloud);
- Import the SHP file into G7 Farmnavigator following the import procedure (Par 5.2).

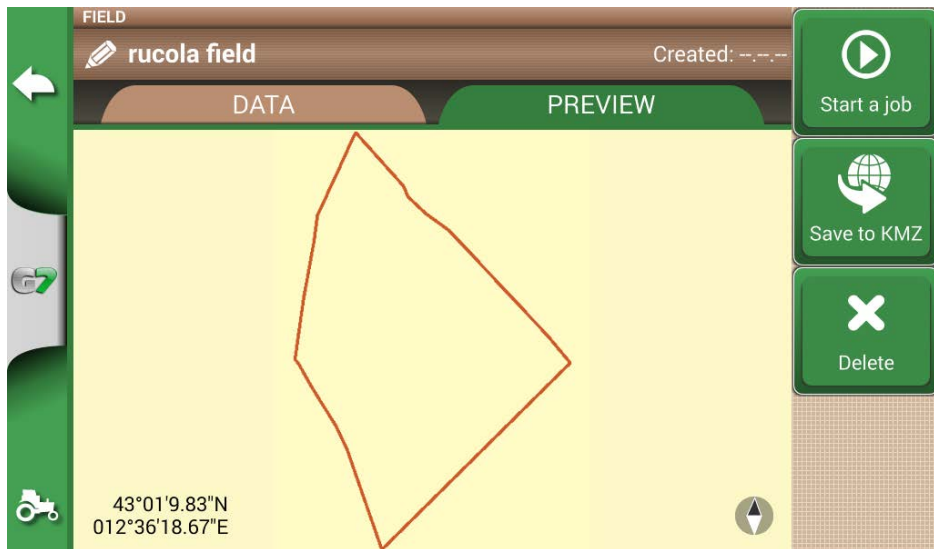


Figure 5.3.g SHP file created with Google Earth™

6. Other functions

6.1 G7 Farmnavigator software updates

The updates for G7 Farmnavigator are available every year. Follow the above procedure to update the software of your device.

6.1.1 Software Update via WiFi (G7 Plus only)

G7 Farmnavigator is provided with an automatic search for available updates when the device is connected to a WiFi network. To search for software update:

1. Tap "SET UP"> System info > "Check for updates" and wait for the connection;

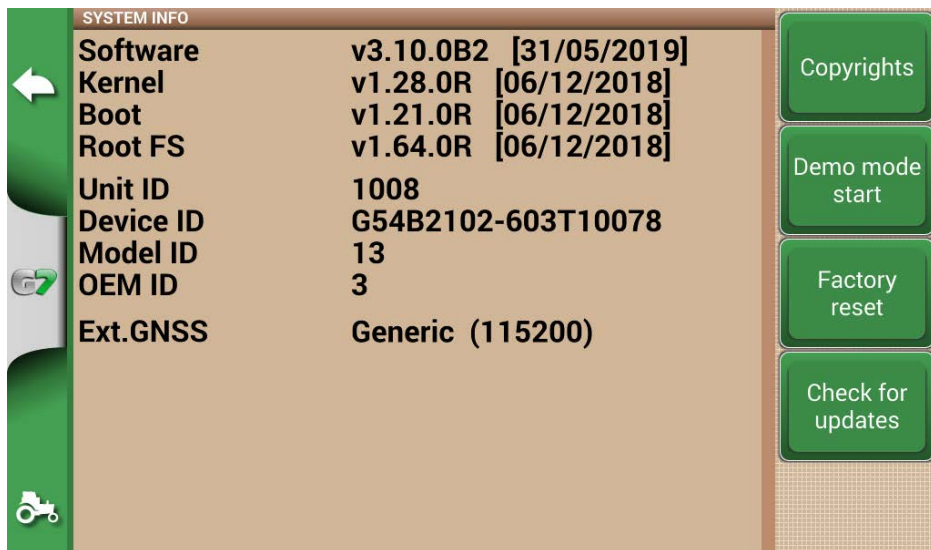


Figure 6.1.a Software update via WiFi

1. Tap "YES" to download the update;
2. The device restarts in update mode;
3. Tap "UPDATE NOW" to proceed with the installation;
4. Tap "CONTINUE" and wait for the restart;
5. The update is completed and the WiFi network can be turned off.

6.1.2 Software Update via USB

If it is not possible to update the software via WiFi due to the lack of connection or since you have a G7 Ezy, you have to update the software via USB.

To proceed with the update, you need:

- USB stick (at least 2GB);
- Update file (it is strongly suggested to contact the customer service);

- 'USB Cable/ Video in' (g7 Ezy, p/n: K2CYFS0600) or cable USB / Video in / Ethernet' (G7 Plus, P/N: K2CYFS1000).

Perform the following procedure:

1. Copy the update file from a PC to USB stick;
2. Connect USB cable to the G7 Farmnavigator bracket;
3. Insert USB stick into the USB connector of the supplied cable;
4. Turn G7 Farmnavigator on, the device starts in update mode;
5. Tap "UPDATE NOW" to install the update;
6. Tap "CONTINUE" and wait for the program to start;
7. The update is now completed and the USB stick can be dismissed.

6.2 Video camera

G7 Farmnavigator allows you to connect an external, analogic video camera. There are no settings to be performed on the software.

6.2.1 Type of supported cameras

G7 Farmnavigator supports analogic cameras with PAL o NTFS format.

The video camera must be provided with a male RCA connector. Power to the video camera must be supplied externally to G7 Farmnavigator. IP and USB camera are not supported. Power must be supplied externally.

6.2.2 Connect a video camera

It is possible to connect a video camera to G7 Farmnavigator via the 'USB cable/Video in' (G7 Ezy, P/N: K2CYFS0600) or 'USB cable / Video in /Ethernet' (G7 Plus, P/N: K2CYFS1000). The cable is provided with an analog RCA female video input.

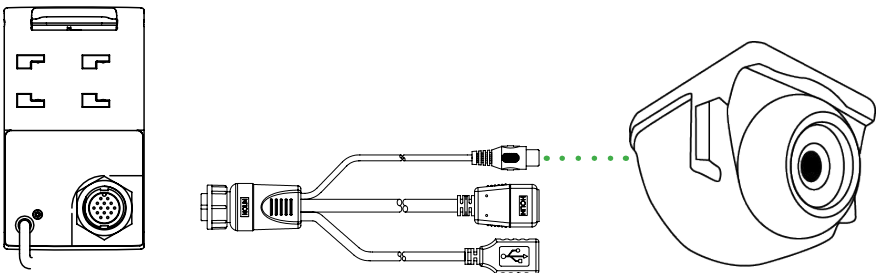


Figure 6.2.a How to connect a video camera to G7 Farmnavigator

6.2.3 Display mode for Video camera

When the camera is properly connected to G7 Farmnavigator, the video camera icon will be automatically activated on the main page of your job.

- Tap the camera icon displayed on the main page of your job to switch to video mode.



	<p>Video camera available The video camera is recognized and connected.</p>
	<p>Video camera not available The video camera is not connected or not compatible.</p>

Table 6.2.b Camera button

6.3 G7 Navi (Only for G7 Plus)

G7 Navi is an app used for terrestrial navigation. It is available only for G7 Plus and it allows you to use road navigation function. To switch to this modality:

- In the main page, tap the button located at the upper left side of the page;



Figure 6.3.a Access to G7 Navi

- Tap "YES"

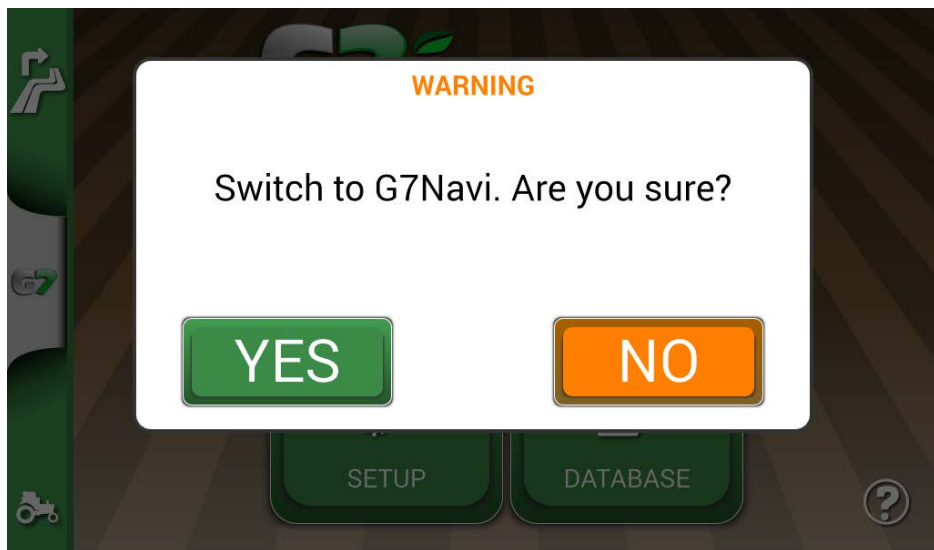


Figure 6.3.b Switch to road navigator confirmation page

6.4 Activate a virtual NMEA output on the “Generic” port

Some third-party devices used on the tractor in complementary mode to G7 Farmnavigator, require the use of GPS antenna for a correct functioning.

G7 Farmnavigator gives the possibility to generate and share a GPS code in NMEA format to be sent to a third-party device, without using a second GPS antenna.

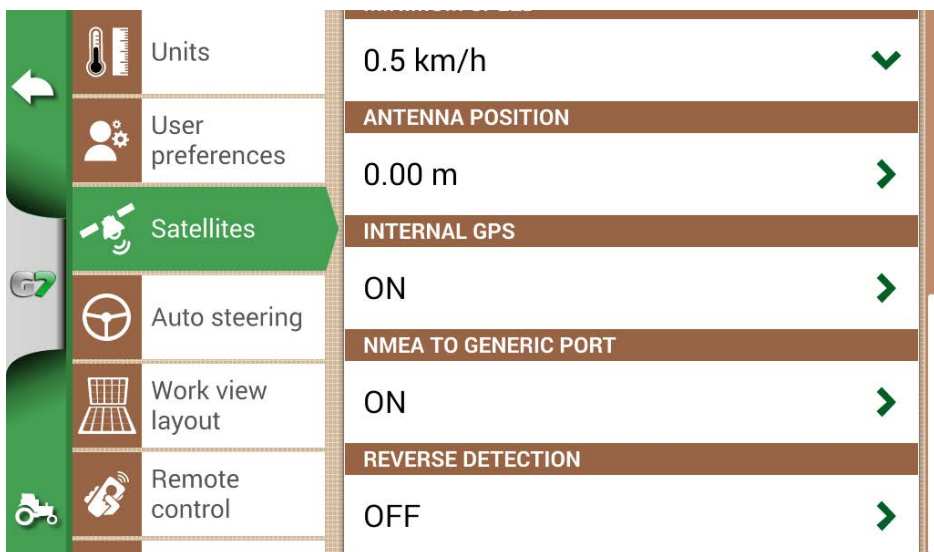


Figure 6.4.a Virtual GPS output on the 'Generic' port

1. Tap "SETUP" > "Satellites"
2. Tap "NMEA on Generic port" and select "ON".

6.5 Activate the demo mode

G7 Farmnavigator is provided with a Demo mode, very useful for outdoor demonstrations without GPS.

To enable the demo mode (Demo):

1. Tap "SETUP" > "System info"> "Start demo mode";
2. Tap the tractor icon located in lower right corner of the page to switch to the job page.

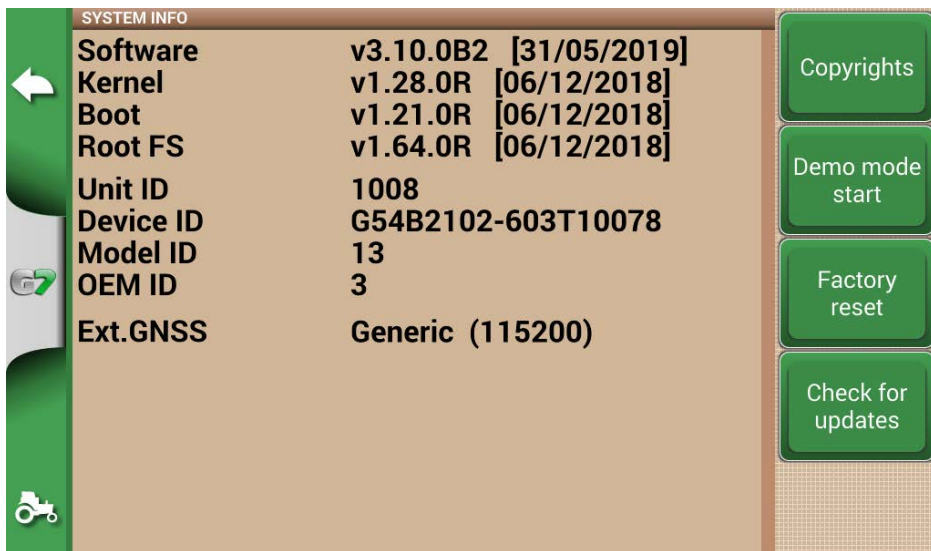


Figure 6.5.a Start demo mode

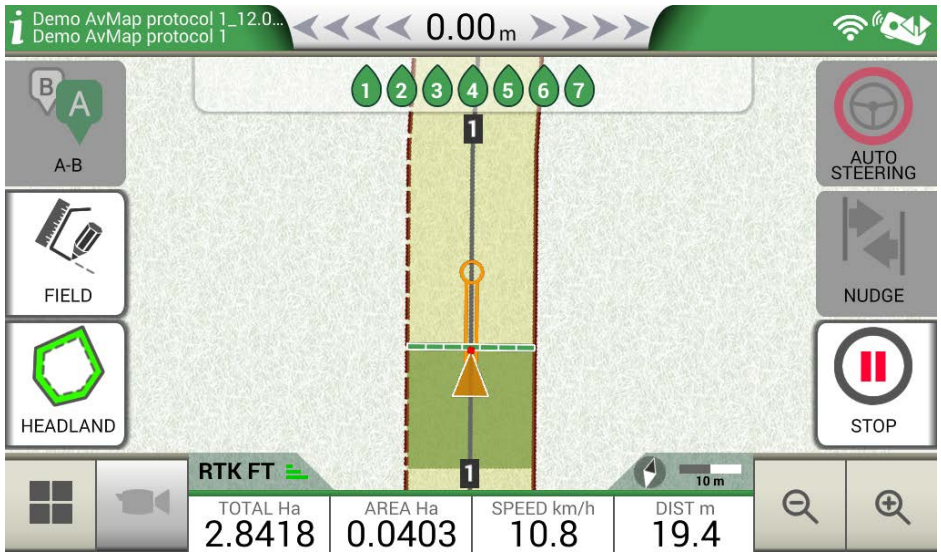


Figure 6.5.b Demo mode

ATTENTION: do not use demo mode if the GPS antenna is connected to the connector of the G7 Farmnavigator bracket marked as “GPS ANTENNA”.

To disable Demo mode:

- Tap “Demo mode stop”;

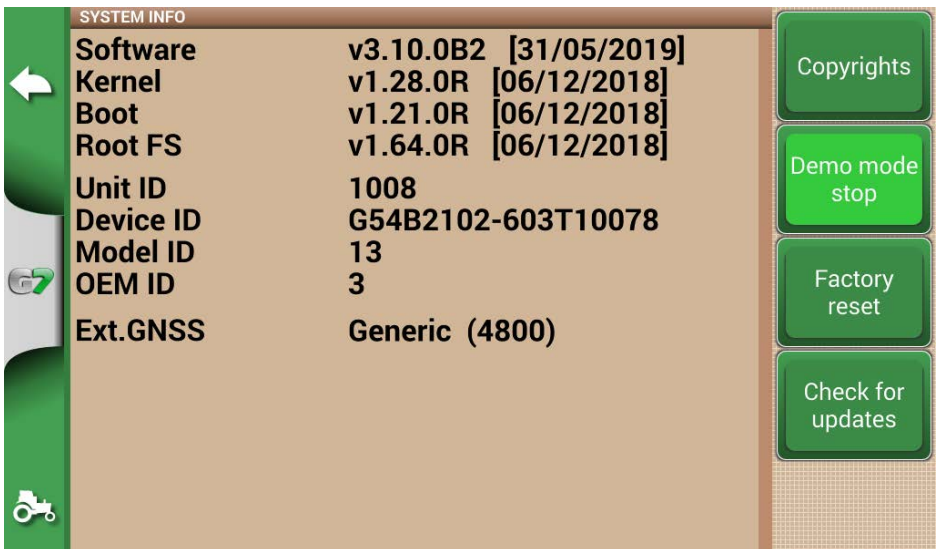


Figure 6.5.c Demo mode stop

7. Contacts/Customer Support

To get first-level assistance regarding:

- User manual guide
- Warranty
- Replacements, malfunctions
- Repairs
- Updates

Telephone: +39 0585 784044

Mail: support@avmap.it

To get second-level assistance regarding:

- Autosteering
- RTK systems
- Settings

Telephone: +39 334 6033178

Mail: support.farm@avmap.it

8. Appendix

List of third-party devices compatible with G7 Farmnavigator:

Antenna

- AvMap Smart Turtle
- Novatel AgStar
- Novatel Smart6
- Novatel Smart7
- Harxon TS108Pro

Sprayer

- Agral AGSIG
- Agromehanika AG-Tronik
- Bertolini Buono
- Caffini CB9
- FarmscanAG UniPOD
- Geoline GeoSystem 260
- MC Elettronica Hydra 590

Spreader

- Bogballe Icon
- Bogballe Zurf

Planter

- Gpskit AgriDrive

Analytic Index

A

Antenna 3, 5, 6, 7, 24, 25, 33, 36, 51, 60, 61, 73, 75
Auto-Steering 3, 5, 26, 28, 33, 41, 42, 61

C

Customer Support 3, 76

D

Demo mode 3, 74, 75
Distance from the plant 61
Driver 3, 10, 11, 45, 48

E

Electrical connections 5
Export 5, 62, 63

F

Farmer 11, 12, 13, 45, 46, 47
Field 3, 5, 8, 13, 35, 36, 37, 38, 39, 41, 45, 46, 47, 48, 49, 50, 58, 60, 61, 63, 64, 65, 67, 68

G

Google Earth™ 5, 62, 63, 68, 69

H

Headland 3, 39, 40, 41
Import 3, 5, 37, 62, 63, 64, 65, 66, 67, 69

J

Job 3, 9, 10, 17, 19, 20, 22, 23, 26, 28, 32, 33, 34, 35, 36, 38, 39, 42, 43, 45, 46, 47, 48, 49, 50, 57, 59, 61, 62, 63, 71, 74
Job name 3, 32, 45, 46

K

KMZ 3, 62, 63, 64, 65, 66, 69

M

Magnet 3, 36, 48, 50, 51
Mirror-Control 30

N

Nozzles 54, 55
Nudge 3, 26, 29, 43, 44
Number of worked plants 61

O

Obstacle 28, 41, 42, 50

P

Planter 58, 59, 61, 77
Products 3, 13, 45

R

Remote control 3, 27, 28, 29, 32, 41

S

Satellites 3, 24, 25, 33, 74
Sections 3, 5, 33, 41, 51, 53, 54, 55, 56, 57, 58
Sections control 33, 41
Start 19, 20, 26, 29, 34, 37, 39, 45, 46, 47, 48, 71
Stop 3, 26, 29, 34, 75
Streets 36, 51

T

Total area 34

U

Units 3, 23, 24
Updates 3, 31, 70, 76
USB 3, 62, 63, 64, 65, 66, 70, 71
User preferences 3, 24

V

Video camera 3, 71, 72

W

Worked area 26, 29, 34, 39, 46
Working width 17
Work view layout 3, 26, 27, 78

Z

Zoom 3, 8, 29, 33

MAG7XAM0AE010

