



SWR 1

Radome 0.9 Feet

SWR 8

Radome 1.5 Feet

SWR 9

Radome 1.8 Feet

SWR 10

Open 3.5/4.5 Feet

Copyright 2010 Seiwa - Hong Kong

All rights reserved. Printed in Italy. No part of this publication may be reproduced or distributed in any form or by any means, or stored in a database or retrieval system, without prior written permission of the publisher.

User Manual

code: (E 250510e)

Safety Precaution

HIGH VOLTAGE WARNING

Dangerously high voltages are present within the RADAR scanner unit. There are no internal connections or adjustments necessary for installation. Only a qualified radar service technician should remove the cover. Technicians must exercise extreme care when working inside the unit. Always remove power before removing the cover. Some capacitors may take several minutes to discharge, even after switching off the radar. Before touching the magnetron or any high voltage components, ground them with a clip lead.

MICROWAVE RADIATION HAZARD

The microwave energy radiated by a radar antenna is harmful to humans, especially to one's eyes. Never look directly into an open waveguide or into the path of radiation from an enclosed antenna. Radar and other radio frequency radiation can upset cardiac pacemakers. If someone with a cardiac pacemaker suspects abnormal operation, immediately turn off the equipment and move the person away from the antenna. Turn off the radar whenever it is necessary to work on the antenna unit or on other equipment in the beam of the radar.

MAGNETRON PREHEATING

When starting your RADAR for the first time or when restarting it after a two month or longer non-operating period, preheat the magnetron at least 30 minutes in standby mode.

Please read through this manual before the first operation. If you have any questions, please contact the Company's customer service or your local dealer.

Contents

Safety Precaution	4
HIGH VOLTAGE WARNING	4
MICROWAVE RADIATION HAZARD	4
MAGNETRON PREHEATING	4
About this User Manual	7
INTRODUCTION	7
CONVENTIONS USED	7
HOW THIS USER MANUAL IS ORGANIZED	7
IF YOU NEED ASSISTANCE	8
EQUIPMENT SUPPLIED	8
Optional Equipment	8
1. Radar Installation	9
1.1 INSTALLATION CONSIDERATIONS	9
1.2 PREPARE THE RADAR FOR INSTALLATION	9
1.3 INSTALLATION PROCEDURE	10
1.4 ELECTRICAL AND DATA CONNECTIONS	10
1.5 CONNECTION PROCEDURE	10
1.6 RADAR JUNCTION BOX CONNECTIONS	11
1.6.1 Jumper To Control Radar On/Off Operation	13
1.6.1.1 Radar Powered On all the time	13
1.6.1.2 Radar Powered On/Off Controlled by an External Switch	13
1.6.1.3 Radar Power On/Off Controlled by the Chart Plotter Software	13
1.6.2 Alternative Power Connection	13
1.6.2.1 Power Connections	13
1.7 SOFTWARE CONFIGURATION	13
1.7.1 I/O Setup	13
1.7.2 Warming Up	14
1.7.3 Transmission On	14
1.7.4 Radar calibration	14
1.7.4.1 Heading Line	14
1.7.4.2 Antenna Parking Position	14
1.7.4.3 Sector Transmission Off	15
1.7.4.4 Transmission Trigger Delay	15
1.7.4.5 Automatic and Manual Tune	18
Manual Tune	18
Automatic Tune	19
1.7.4.6 Save Tuning to User C-CARD/MEDIA	20
1.7.4.7 Load Tuning from C-CARD/MEDIA	20
2. Functions	21
2.1 BASIC	21
2.1.1 Cross Cursor	21
2.1.2 Chart Overlay	21
2.1.3 Range	22
2.1.4 Orientation	22
2.1.5 Motion Mode	22
2.1.6 Echo Trails Settings	23
2.1.7 Target Expansion	23
2.2 SENSITIVITY	23
2.2.1 Interference Rejection	23
2.2.2 Gain Adjustment	23
2.2.3 STC (Sensitivity Time Constant) Adjustment	23
2.2.4 FTC (Fast Time Constant) Adjustment	24
2.2.5 MBS (Main Bang Suppression) Adjustment	24
2.3 RADAR FEATURES	24
2.3.1 Cursor Window	24
2.3.2 Heading Marker	25

2.3.2.1	Handling of Heading Marker	25
2.3.3	Degree Scale	25
2.3.4	Range Rings	26
2.3.5	Compass Rose	26
2.3.6	EBL & VRM	27
2.3.6.1	Handling of EBL/VRM	28
2.3.7	Parallel Cursor	28
2.3.7.1	Handling of Parallel Cursor	28
2.3.8	Center Offset	29
2.3.8.1	Handling of Center Offset	29
2.3.9	AIS Target	29
2.4	CHART FEATURES	29
2.4.1	Chart Overlay Mode	29
2.4.2	Chart Synchronization	30
2.4.3	Cursor Echo	30
2.4.4	Waypoints	30
2.4.5	Marks	31
2.4.6	Info on Objects	31
2.5	GUARD ZONES	31
2.5.1	Handling of Guard Zone	31
2.5.2	Guard Zone Sensitivity	32
3.	Radar Pages	33
3.1	PAGES SELECTION	33
3.1.1	Selection by Soft Key	33
3.2	STATUS BAR	34
3.3	MENU HANDLING ON FULL PAGES	35
3.4	SELECTION OF THE "ACTIVE" VIEW IN SPLIT/COMBO PAGES	35
4.	Technical Specifications	37
4.1	SWR 1	37
Antenna unit	37	
Dimensions and Mounting	37	
4.2	SWR 8	38
Antenna unit	38	
Dimensions and Mounting	39	
4.3	SWR 9	39
Antenna unit	39	
Dimensions and Mounting	40	
4.4	SWR 10	41
Antenna unit	41	
Dimensions and Mounting	41	
5.	Troubleshooting	43
6.	Frequently Asked Questions	45
A.	What is Radar?	49
A.1	GENERAL	49
A.1.1	Antenna	49
A.1.2	Side Lobe	49
A.2	CHARACTERISTICS OF RADAR WAVE	50
A.2.1	Targets difficult to display on screen	50
A.2.2	Shadow zones of Radar	50
A.2.3	False echoes	51
A.2.3.1	Ghost echoes	51
A.2.3.2	Multiple echoes	51
A.2.3.3	False echoes caused by side lobe	51
A.2.3.4	Distant False echoes caused by duct phenomenon	52
A.2.3.5	Radar interference	52
B.	Installation	53
B.1	MORE INSTALLATION CONSIDERATIONS	53
B.1.1	Shifting from keel line	53
B.1.2	Obtaining sufficient dip angle	53
B.2	INSTALLING SCANNER UNIT	53
Analytical Index		55

About this User Manual

INTRODUCTION

Your RADAR consists of two main components, the RADAR scanner unit and a Chart Plotter display unit. The display unit is a user-supplied plotter capable of running the Radar operating application. The RADAR scanner unit includes the radar antenna, transmitter, receiver and necessary electronics to deliver Radar information to the user's chart plotter. The mounting hardware kit, interconnection cable and a Radar junction box are included in the Radar scanner box.

Any menu operation and functions activation in this User Manual is related to the following chart plotter models (see the following table). Whenever it is necessary, a note has been inserted for those models with operational differences.

CHART PLOTTER NAME	SOFTWARE	SN	Radar Serial Port	Available from Sw
SW701e	S4x2SW8wc	All	2 or 5	16.00
SW701i	S4x2SW8wc	All	2 or 5	16.00
SW701ce	S4x2SW8wc	All	2 or 5	16.00
SW701ci	S4x2SW8wc	All	2 or 5	16.00
SW1101	S5e2SW11c	All	2 or 5	16.00
EXPLORER ³	S5egSWctc	All	2 or 5	11.00
SEAWAVE ³	S5egSW12c	All	2 or 5	11.00
MARLIN	S5egSW15c	All	2 or 5	11.00

The Radar full functionality, as described in this User Manual, is obtained only when the scanner is included in an integrated system including chart plotter, gyrocompass and GPS antenna.

Please read carefully this User Manual to learn the operating features for your Radar. Please refer to your chart plotter User Manual for all other operating instructions.

CONVENTIONS USED

Throughout this User Manual, the labelled keys are shown in capital letters enclosed in square brackets, for example [ENTER]; the software/function keys are shown in small letters enclosed in square brackets, for example [Edit].

Menu operations are in bold characters listed by keys sequence with the menu names enclosed between inverted commas, for example **[MENU] + "ALARMS"** + [ENTER] means: press the [MENU] key, using the cursor key select the Alarms menu and then press [ENTER].

HOW THIS USER MANUAL IS ORGANIZED

- ♦ **CHAPTER 1: Radar Installation**
Installation of the Radar and set up of the hardware configuration.
- ♦ **CHAPTER 2: Functions**
How to connect the chart plotter and the Radar; and how to operate them.

- ◆ **CHAPTER 3: Radar Pages**
Description of the available Radar pages, full and split pages.
- ◆ **CHAPTER 4: Technical Specifications**
Technical specification and dimensions of the Radar.
- ◆ **CHAPTER 5: Troubleshooting**
- ◆ **CHAPTER 6: Frequently Asked Questions**
- ◆ **APPENDIX A: What is Radar?**
- ◆ **APPENDIX B: Installation**

The Analytical Index is at the end of this User Manual.

IF YOU NEED ASSISTANCE

If your chart plotter does not operate properly, please refer to the chart plotter User Manual.

EQUIPMENT SUPPLIED

- ◆ Scanner Unit, Radar scanner with cable
- ◆ Fasteners, stainless steel:
 - 4 Bolts, hex metric M8 x 25U (approx. 3/8 dia. x 1 in. long)
 - 4 Flat washer
 - 4 Lock washer
- ◆ 1 Radar Junction Box
- ◆ 1 Template, for locating mounting holes
- ◆ 1 Switch, Rocker type, DPST
- ◆ 2 Fuses, 5A (spare)

Optional Equipment

- ◆ Magnetic Heading Sensor
- ◆ Extended length cables, 15 or 20 meters

1. Radar Installation

This chapters illustrates the instructions on electrical connections of the Radar and the necessary software settings to operate it.

WARNING

In order for the Radar to communicate with the Chart Plotter, the software configuration explained in the Par. 1.7 is mandatory.

1.1 INSTALLATION CONSIDERATIONS

Prior to the actual installation of the RADAR scanner unit, several factors must be considered to ensure maximum performance. The scanner must be located so that passengers and crew are not exposed to the direct Radar beam. The scanner unit should be mounted on the centerline of your vessel in a location that has an unobstructed view forward and the rest of the area around the scanner is as unobstructed as possible. A location as high as practical to improve maximum range is preferable, keeping in mind that minimum range objects may be overlooked if mounted too high. Place the units in before large structures and exhaust stacks. Large structure or stacks cause blind spots. Contamination from engine exhaust on the scanner housing reduces radar performance.

Antennas for GPS, radio communication or other equipment should not be in the radar beam. Use non-metallic extension poles to move the active area of antennas above the radar beam.

In selecting a location, consider the suitability of the mounting surface. It must be flat and approximately levelled with the vessel's water line. The surface must support the weight of the scanner and have access to the under side for installation of the four mounting bolts.

NOTE *The recommended mounting surface thickness is 3/8 to 1/2 in. (9 mm to 13 mm). If the mounting surface is thin, a doubler should be added. If it is thicker, longer bolts must be purchased. The scanner will be damaged if bolts penetrate more than 9/16 in. (15 mm).*

Also, consider the cable route from the scanner to the operator's location. Avoid routing the interconnecting cable through areas of possible damage from moving objects, machinery, and exposure to chemicals or high temperature.

1.2 PREPARE THE RADAR FOR INSTALLATION

Unpack your new RADAR and check that the contents correspond to the packing list. Do not remove the cover from the unit. There are no connections or adjustments inside the unit that are needed for installation or operation. The cable must remain attached. For ease of handling, coil the cable and place it on top of the scanner. Then secure it with tape. Invert the scanner and make sure the four mounting holes are clear to accept bolts.

Working at higher elevations may become necessary while installing the scanner unit. Observe safety measures and take sufficient precaution to avoid personal injury or damage to the equipment.

1.3 INSTALLATION PROCEDURE

- Prepare the mounting surface by making sure it is clean and flat.

NOTE *It is a better to check the accuracy of the template by measuring the actual dimension between the hole locations. The reproduction process and moisture absorption can affect accuracy.*

- Use the template provided to mark the location of four mounting holes. Align the template squarely with the centerline of the vessel and with the arrow pointing forward.
- Drill four 3/8 in. (10 mm) diameter holes through the mounting surface.
- Check that each bolt (with lock washer and flat washer) protrude through the mounting surface at least 5/16 in. (8 mm) but less than 9/16 in. (15 mm). The scanner will be damaged if bolts protrude more than 9/16 in. (15 mm).
- Apply sealant around each mounting hole.
- Place the Radar scanner unit on the mounting surface. Orient the scanner with the index mark on the housing facing forward (cable gland facing aft).
- Install and tighten four M8 x 25U (M8 x 1 in.) mounting bolts.
- Uncoil the scanner cable.
- Secure the cable near the scanner to support the weight of the cable and prevent strain on the watertight cable seal. If the cable is to pass through tubing or a bulkhead, protect the unfinished end. Do not use the unfinished wires or fabric braid to pull the cable. Attach a fish cord only to the cable jacket.
- Route the cable to the operator's location, securing it at appropriate points along the way. Make a drip loop and apply sealant at the entry point of an exterior bulkhead.

1.4 ELECTRICAL AND DATA CONNECTIONS

The cable from RADAR scanner unit provides all power, data and control connections necessary for operation. The large black and white leads are for power connections and connect directly to a 12 to 24 VDC power buss; the five small leads, in the fabric braid, connect to the Radar Junction Box; and the two remaining small leads connect to the On/Off control switch. The On/Off control switch does not switch the main power leads to the scanner unit, but it does provide a signal that controls DC power inside the scanner unit.

1.5 CONNECTION PROCEDURE

NOTE *In the following procedures, small wires must be stripped and tinned, and then connected to the proper connections in the Radar Junction Box, and to pins on the On/Off control switch. If you are uncertain of your skill in completing these tasks, it is strongly advised to obtain the services of a qualified technician. It is essential to the operation and reliability of your RADAR that these procedures are accomplished properly.*

- Arrange the free end of the scanner cable so that the unfinished leads will reach their intended points for connections. The two large wires must reach a power panel; the five leads in the braided fabric jacket must reach the Radar Junction Box and the two remaining leads must

reach the desired location for the On/Off control switch. If the leads must go in different directions, first route the five leads in the fabric braid to the Junction Box. Then extend the shorter leads using the same size or larger size wire.

1.6 RADAR JUNCTION BOX CONNECTIONS

Referring to the diagram below, connect the color coded wires from the Radar cable to the designated place on Terminal strip A in Radar Junction Box as follows.

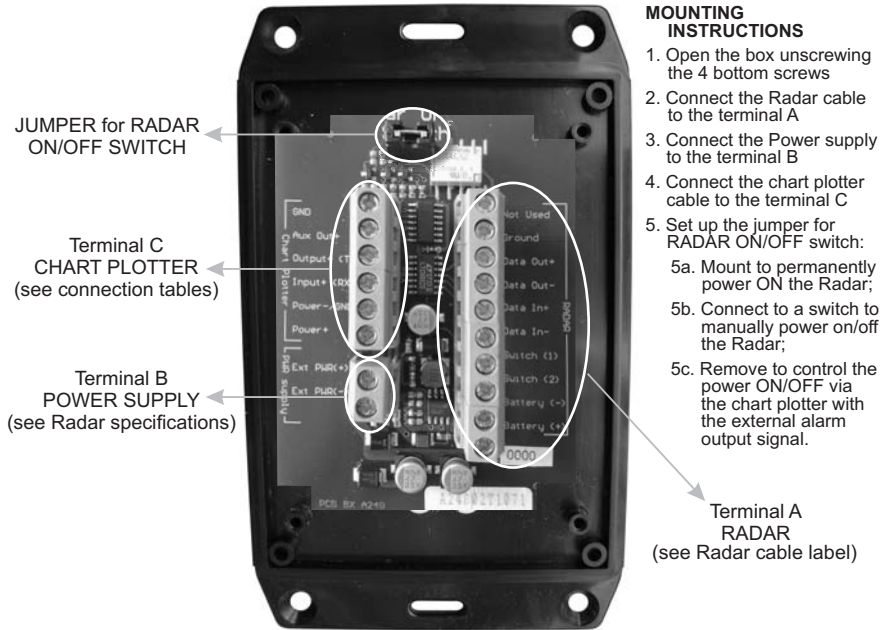

Fig. 1.6 - Junction Box

Terminal Strip A

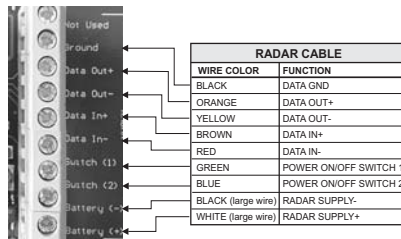

Fig. 1.6a - Terminal Strip A Connection for SWR 1/SWR 8/SWR 9

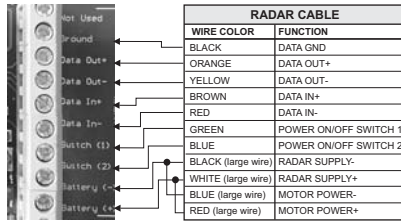

Fig. 1.6a1 - Terminal Strip A Connection for SWR 10

Terminal Strip B IS TO BE CONNECTED TO POWER SUPPLY (12 TO 24 VDC NOMINAL)
 Do not omit the in-line fuse unless a dedicated and fused terminal is available. If so, install a 5 Amp fuse. If you are installing a SWR 10 open scanner Radar, it is important to also connect the Red (+) to positive power terminal, and Blue (-) to negative power terminal, as this provides power to scanner motor.
 This terminal leads the power to the Scanner unit and to the chat plotter (*).

NOTE(*)*Only if the chart plotter power wires are connected to Terminal strip C, on B+ and GND terminals.*

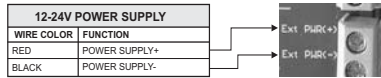

Fig. 1.6b - Terminal Strip B

WARNING

Please make sure that the connected power supply is able to supply the current at the voltage required by the Radar to operate.

Terminal Strip C

See connection tables to determine proper way to connect the chart plotter to Radar Junction Box.

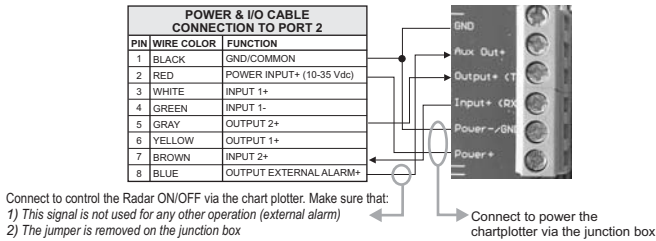

Fig. 1.6c - Connection to Port 2

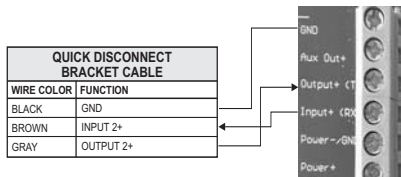

Fig. 1.6c1 - Connection to Port 2 for Quick Disconnect Bracket Cable

1.6.1 Jumper To Control Radar On/Off Operation

1.6.1.1 Radar Powered On all the time

Leave jumper located at top of Radar Junction Box mounted. This will keep powered On at all times.

1.6.1.2 Radar Powered On/Off Controlled by an External Switch

The two remaining small leads, the Green wire and the Blue wire, connect to the On/Off control switch. The On/Off control switch does not switch the main power leads to the scanner unit, but it does provide a signal that controls DC power inside the scanner unit.

1.6.1.3 Radar Power On/Off Controlled by the Chart Plotter Software

Remove jumper. Connect the EXTERNAL ALARM signal of the chart plotter to TERMINAL Strip C, Terminal ALR (see connection tables).

Setting up the chart plotter I/O in the following mode:

- [MENU] + "Advanced Options" + [ENTER] + "Input/Output" + [ENTER] + "External Signal" + [ENTER] + "External Alarm" + [ENTER]

Power the Radar On/Off directly from the Radar page:

- [MENU] + "POWER" + [ENTER] + "ON"/"OFF" + [ENTER]

1.6.2 Alternative Power Connection

You can feed the Power supply to the Radar directly.

1.6.2.1 Power Connections

- ◆ Route the large black and white wires directly to the power panel. No switch is required.
- ◆ Connect the large black wire to the battery negative (—) terminal of the power panel.
- ◆ Connect the large white wire (with the in-line fuse) to the battery positive (+) terminal of the power panel (12 to 24 VDC nominal). Do not omit the in-line fuse unless a dedicated and fused terminal is available. If so, install a 5 Amp fuse. If you are installing a SWR 10 open scanner Radar, it is important to also connect the Red (+) to positive power terminal, and Blue (-) to negative power terminal, as this provides power to scanner motor.

This completes the installation of your Radar scanner unit.

Please proceed with setting up the data ports in your chart plotter, following the instructions below.

1.7 SOFTWARE CONFIGURATION

First you have to install the Radar. Refer to the following paragraphs to configure the chart plotter to operate with the Radar.

1.7.1 I/O Setup

Setting up the chart plotter I/O depends upon which port is used to connect the Radar. If you use the connecting cable supplied with the Radar, the Port2 is the default setting. In this case follow the procedure:

- [MENU] + "Advanced Options" + [ENTER] + "Input/Output" + [ENTER] + "Port 2 Input" + [ENTER] + "Radar" + [ENTER]

1.7.2 Warming Up

It has to be noted that at start-up the Radar needs a variable time from 90 to 120 seconds to heat up the magnetron (microwave emitting tube). During this time it is not possible to turn on the transmission.

Radar pages are visible but with a small overlapping message window showing the time remaining to Warm Up completion:

"Radar Warming Up! xx seconds remaining!"

At completion of the Warm Up sequence the following message will be displayed:

"Radar Warming Up! Warm Up Completed!"

This window shall remain open for 2 seconds, then it will close automatically.

At this point the Radar is ready for operation. Transmission is turned Off and "STAND BY" message is displayed at the center of the Radar page.

1.7.3 Transmission On

Turn On the transmission pressing:

- [ENTER]

NOTE *or following the procedure:*

- [MENU] + "Transmission" + [ENTER] + "On" + [ENTER]

or using soft/function keys:

- any soft/function key + [TX]¹

NOTE¹ *For SEAWAVE[®], press [4, TX].*

The Radar image is displayed on the screen.

1.7.4 Radar calibration

At first installation it is necessary to properly calibrate the Radar:

- [MENU] + "Tuning" + [ENTER]

The Radar calibration includes:

- ◆ Heading Line
- ◆ Antenna Parking Position (ONLY FOR SWR 9/SWR 10)
- ◆ Sector Transmission Off (ONLY FOR SWR 9/SWR 10)
- ◆ Transmission Trigger Delay

1.7.4.1 Heading Line

This function is used if the Radar Antenna was not installed pointing directly parallel with the centerline of the vessel. Adjusting the heading line ensures that targets are shown relative to your ship's bow.

- ◆ select Head Up mode
 - [MENU] + "Orientation" + [ENTER] + "Head Up" + [ENTER]
- ◆ Press [CLEAR] until the Radar page is shown.
- ◆ Select a target about 1- 2NM and adjust the vessels speed to accurately head to the target (preferably on a flat calm day).
- ◆ If the target is not shown directly ahead on the Radar full page display, adjust heading the line to correct the target heading:
 - [MENU] + "Tuning" + [ENTER] + "Heading Line" + [ENTER] + Apply the Heading Correction + [ENTER]
- ◆ The screen updates as the heading line is adjusted. Repeat the steps until the target is shown correctly.

1.7.4.2 Antenna Parking Position

AVAILABLE ONLY FOR SWR 9/SWR 10

When the Radar is turned Off, the antenna comes to a stop. If you want to have the antenna to stop in a specific position, the Antenna Parking Position function can be used to choose the desired antenna position. This function only controls the antenna position at which the power to the motor is cut off. The distance through which it comes to a stop from this point depends on temperature and

wind conditions. The setting of antenna does not affect the operation of the Radar at all. To set the antenna position follow this procedure:

- [MENU] + "Tuning" + [ENTER] + "Antenna Parking Position" + [ENTER]

Use the cursor keys to adjust the position (between 0 and 90).

The displayed number represents the change from the default setting. The final setting that parks the antenna straight ahead will likely be a few degrees left or right from the default setting.

1.7.4.3 Sector Transmission Off

AVAILABLE ONLY FOR SWR 9/SWR 10

This is used to block transmission and target reflection in some special application for fixed installation like sea watching. Within this sector, targets can not be detected.

Selecting the Sector Transmission Off from the menu:

- [MENU] + "Tuning" + [ENTER] + "Sector Transmission Off" + [ENTER]

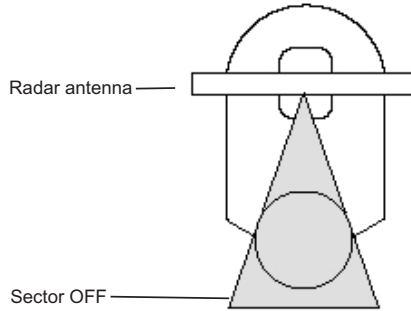

Fig. 1.7.4.3 - Sector Off

1.7.4.4 Transmission Trigger Delay

Tuning the Transmission Trigger Delay (TTD) allows making accurate distance measurement. In practice, you need to align the start of the sweep with the leading edge of the transmission pulse.

IMPORTANT: The unit comes with a default Tuning value already setup by the factory but to obtain maximum precision you should finely adjust this value. Use the following procedure.

- ❖ Enter the Transmission Trigger Delay page.
 - [MENU] + "Tuning" + [ENTER] + "Transmission Trigger Delay" + [ENTER]
- Since the STC is automatically turned off when entering this page, the screen appear completely covered with clutter, this is a mandatory condition to allow properly setting the TTD. The screen should appear as follows:

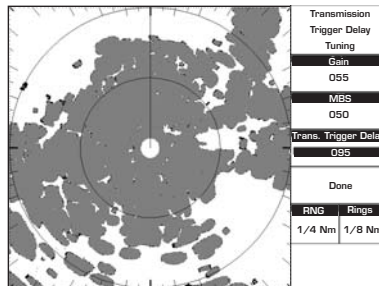

Fig. 1.7.4.4 - Transmission Trigger Delay tuning (1)

- ◆ Set MBS to 0. The white spot in the Radar origin will disappear.

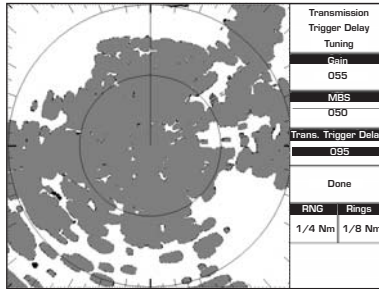

Fig. 1.7.4.4a- Transmission Trigger Delay tuning (II)

- ◆ Slowly decrease the GAIN value until the clutter clears out and you can clearly distinguish a round spot in the Radar origin:

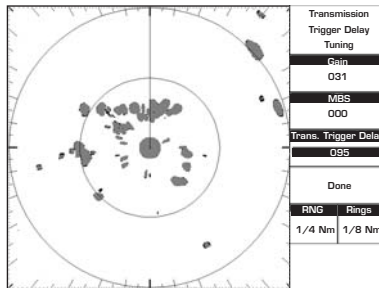

Fig. 1.7.4.4b - Transmission Trigger Delay tuning (III)

- ◆ If the Transmission Trigger Delay is properly tuned the spot in the Radar origin should appear as in the picture above. In any case to be sure your TTD is properly tuned try to decrease the Transmission Trigger Delay until a hole start forming in the center of the round spot:

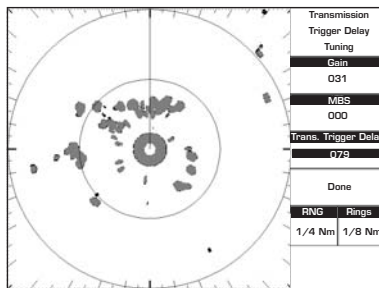

Fig. 1.7.4.4c - Transmission Trigger Delay tuning (IV)

- ◆ Now increase the TTD until the hole closes (not more than just the value to make it close). The increase rate should be very slow: just increase by a single step at the time and wait until you see the effect on the screen. When the hole in the center of the spot closes you have reached the optimal TTD setting.

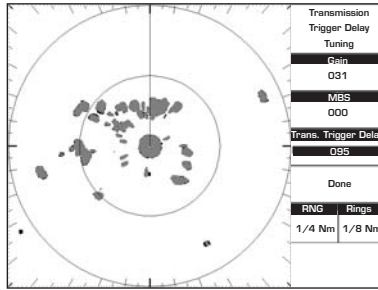

Fig. 1.7.4.4d - Transmission Trigger Delay tuning (V)

- ◆ The spot in the Radar origin is the transmission pulse itself. Targets within such range are not detectable because their echoes are completely overwritten by the Radar still transmitting. Such spot is called Main Bang. To remove it from the screen it is necessary to properly set the MBS (Main Bang Suppression) control. To do this, increase slowly the MBS. The spot is progressively deleted from the inside toward the outside

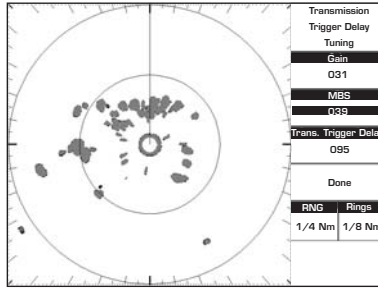

Fig. 1.7.4.4e - Transmission Trigger Delay tuning (VI)

- ◆ Continue increasing the MBS until the spot completely disappears:

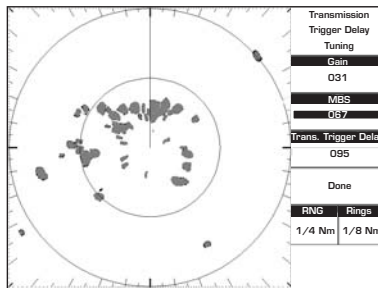

Fig. 1.7.4.4f - Transmission Trigger Delay tuning (VII)

- ◆ Select DONE to exit the TTD tuning menu saving your settings.
- ◆ The main Radar page is displayed. Please note that since initially Gain was decreased, now it's necessary to increase it back in order to achieve maximum sensitivity:

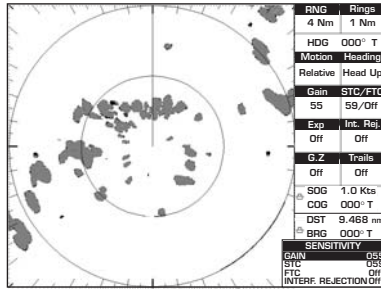

Fig. 1.7.4.4g - Transmission Trigger Delay tuning (VIII)

Once the calibration has been performed, the calibration data is retained. However if a Clear RAM operation is performed it may be necessary to repeat the calibration.

1.7.4.5 Automatic and Manual Tune NOT NECESSARY AT FIRST INSTALLATION

The Tune control is used to tune the receiver in the Radar antenna for maximum target returns on the display. The Radar comes from the factory already tuned so this operation is not necessary at first installation. In general Radar Tuning may be necessary if any component of the Radar is replaced for maintenance.

The Radar receiver can be tuned in Automatic or Manual mode. In Automatic Tune mode, the Radar tunes itself automatically on all range scales. **It is recommended to execute the Tune function in Automatic mode.** This generally ensures that the Radar receiver is always tuned to receive the maximum signal. If you choose the Manual Tune, you will need to adjust it again after 10 minutes, after you have turned on the Radar, since the required setting will change after the magnetron has warmed.

NOTE *The Manual Tune function should be made only by professional operators.*

Manual Tune

To execute manual tuning follow the procedure:

- [MENU] + "Tuning" + [ENTER] + "Manual Tune" + [ENTER]
- ◆ The following Warning message is displayed:



Fig. 1.7.4.5 - Manual Tune Warning message

- ◆ Press [ENTER] to proceed, the Manual Tuning page is displayed:

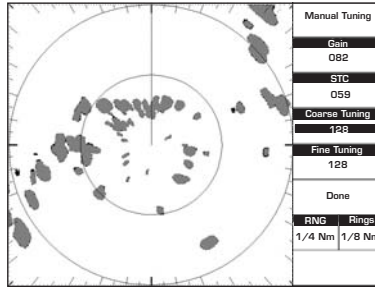

Fig. 1.7.4.5a - Manual Tune page

- Try increasing or decreasing the Course Tuning very slowly and in small steps from its middle value (128) until you obtain the maximum echo returns. If no land or ship targets are available, you may tune for maximum STC.

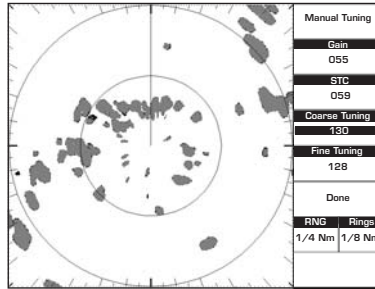

Fig. 1.7.4.5b - Manual Tuning procedure (I)

- Once the Course Tuning has been set, repeat the same procedure with the Fine Tuning:

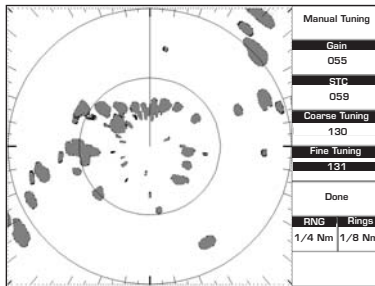

Fig. 1.7.4.5c - Manual Tuning procedure (II)

- Select DONE to exit the Manual Tuning page saving your settings.

Automatic Tune

To execute automatic tuning follow the procedure:

- **[MENU] + "Tuning" + [ENTER] + "Automatic Tune" + [ENTER]**
- The following Warning message is displayed to alert the user that the Auto Tuning procedure may require up to 10 minutes. Please note that during Auto Tuning all the Radar functionalities are disabled.

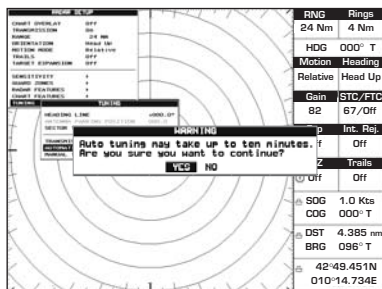

Fig. 1.7.4.5d - Automatic Tune Warning message

- ◆ Press **[ENTER]** to proceed, the Automatic Tuning starts and the following Window is displayed on the screen:

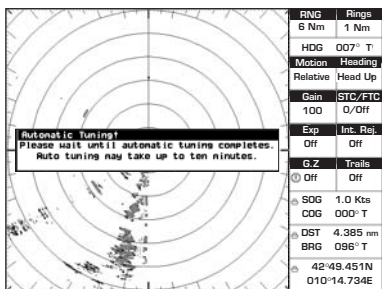

Fig. 1.7.4.5e - Automatic Tune page

- ◆ When the Auto Tuning completes the Warning Message is hidden and all Radar functionalities return to be available.

1.7.4.6 Save Tuning to User C-CARD/MEDIA

This is useful to avoid the user having to retune up Radar after a Clear RAM operation or a software update. The following data will be saved:

- ◆ Heading Line angle
- ◆ Antenna Parking Position
- ◆ Sector Transmission Off Start Angle
- ◆ Sector Transmission Off End Angle
- ◆ Transmission Trigger Delay
- ◆ Course Tune
- ◆ Fine Tune

Insert the User C-CARD/MEDIA into the slot, then follow the procedure:

- **[MENU]** + "Tuning" + **[ENTER]** + "Save Tuning to User C-CARD/Media" + **[ENTER]**

The file name is given automatically as TUNING1.

1.7.4.7 Load Tuning from C-CARD/MEDIA

Loads the complete settings from the User C-CARD/MEDIA and changes the active menu settings. Insert the User C-CARD/MEDIA into the slot, then follow the procedure:

- **[MENU]** + "Tuning" + **[ENTER]** + "Load Tuning from User C-CARD/Media" + **[ENTER]**

2. Functions

2.1 BASIC

2.1.1 Cross Cursor

When on the Full Radar page or when the focus is on the Radar window, moving the Cursor Keys will show the cursor on the screen. It is automatically hidden when the Cursor is not used for more than 5 seconds. It can temporarily be hidden to check for small targets under it by pressing **[CLEAR]**.

When the Cursor Keys are moved a popup window will show the position of the Cursor, the Distance and Bearing from the cursor to the vessels position.

It is context-sensitive. The following table reports the list of objects and the labels that appear under the cursor:

- | | |
|-----------------------|-----|
| ◆ Center of Radar | CTR |
| ◆ EBL/VRM | E/V |
| ◆ Parallel Cursor | /// |
| ◆ Guard Zone | GZ |
| ◆ Ship Heading Marker | HM |

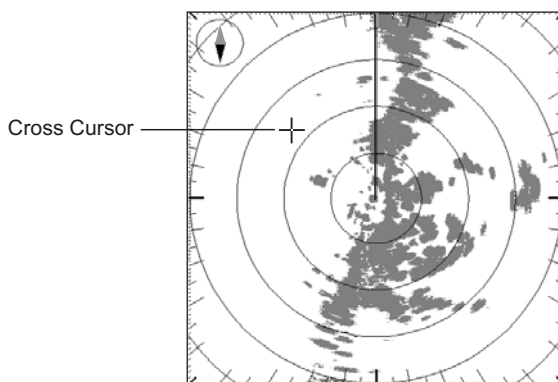

Fig. 2.1.1 - The Cross Cursor in the default Radar picture

2.1.2 Chart Overlay

AVAILABLE ONLY IN THE RADAR FULL PAGE

Chart Overlay function merges Radar and chart data into a single picture by drawing Radar targets over the cartography. When in Chart Overlay mode, the chart inherits the Radar page setting, e.g. Orientation, True Motion mode (for more information refer to Chapter 6, 6.16).

To enable (On) or disable (Off) the Chart Overlay follow this procedure:

- **[MENU] + "Chart Overlay" + [ENTER] + "On"/"Off" + [ENTER]**

NOTE Requires a heading and a position sensor connected to the chart plotter through an NMEA 0183 interface. The heading sensor can be either a gyrocompass or a fluxgate compass. The gyrocompass provides the best performance in all conditions.

To change the Motion mode follow this procedure:

- [MENU] + "Motion Mode" + [ENTER] + select the desired mode between Relative or True + [ENTER]

2.1.6 Echo Trails Settings

Echo Trails causes the persistence of the Radar targets on the screen for the time specified. Selecting an appropriate trail plotting time help determining the speed and course of a target vessel and help prevent collision with it. Selects Radar Trails among Continuous, 15 seconds, 30 seconds, 1 Minute, 3 Minutes, 6 Minutes (or disables - Off). To choose the Echo Trails follow this procedure:

- [MENU] + "Echo Trails" + [ENTER] + select the desired value + [ENTER]

2.1.7 Target Expansion

Target Expansion is used to enlarge the target size without changing the range. This function is useful to see and detect very small targets in open seas. To enable (On) or disable (Off) the Target Expansion follow this procedure:

- [MENU] + "Target Expansion" + [ENTER] + "On"/"Off" + [ENTER]

2.2 SENSITIVITY

To select the Sensitivity menu follow this procedure:

- [MENU] + "Sensitivity" + [ENTER]

NOTE *The Sensitivity menu can be also opened by pressing:*

- [ENTER]
directly from the Radar page when the Cross Cursor is not placed over any features.

2.2.1 Interference Rejection

Reduces the interference caused by Radar signals from other Radar units. It is possible to turn Interference Rejection to Off, Level 1 (weak), Level 2 (middle), Level 3 (strong). The higher you set the Interference Rejection value the less interference you will receive.

To select the Interference Rejection value follow this procedure:

- [MENU] + "Sensitivity" + [ENTER] + "Interf. Rejection" + [ENTER] + select the desired value + [ENTER]

2.2.2 Gain Adjustment

Controls the Radar Gain. To see more details on the screen, increase the receiver sensitivity by selecting a higher gain percentage. If there is too much detail or if the screen is cluttered, lowering the sensitivity may increase the clarity of the display. To select the Gain value follow this procedure:

- [MENU] + "Sensitivity" + [ENTER] + "Gain" + [ENTER] + select the desired value + [ENTER]

NOTE *The Gain can be also controlled by pressing:*

- [Gain]¹
directly from the Radar page, after pressing any software/function key.

NOTE¹ *For SEAWAVE², press [1, Gain].*

2.2.3 STC (Sensitivity Time Constant) Adjustment

Reduces the effects of the sea clutter that can adversely affect displayed targets. To select the STC value follow this procedure:

- [MENU] + "Sensitivity" + [ENTER] + "STC" + [ENTER] + select the desired value + [ENTER]

NOTE *The STC can be also controlled by pressing:*

- [STC]¹
directly from the Radar page, after pressing any software/function key.

NOTE¹ For SEAWAVE³, press [2, STC].

NOTE At low scales (as 1/4 of mile) some attempts are necessary to adjust STC value.

2.2.4 FTC (Fast Time Constant) Adjustment

Reduces the effects of rain, snow, fog and cloud that can adversely affect displayed targets.

To select the FTC value follow this procedure:

- [MENU] + "Sensitivity" + [ENTER] + "FTC" + [ENTER] + select the desired value + [ENTER]

NOTE The FTC can be also controlled by pressing:

- [FTC]¹

directly from the Radar page, after pressing any software/function key.

NOTE¹ For SEAWAVE³, press [3, FTC].

NOTE At low scales (as 1/4 of mile) some attempts are necessary to adjust FTC value.

2.2.5 MBS (Main Bang Suppression) Adjustment

AVAILABLE ONLY FOR SWR 9/SWR 10

The MBS adjustment is fundamental for getting clear near center spot image. In general, you must adjust MBS and STC and Gain to obtain desired Radar image.

To select the MBS value follow this procedure:

- [MENU] + "Sensitivity" + [ENTER] + "MBS" + [ENTER] + select the desired value + [ENTER]

2.3 RADAR FEATURES

2.3.1 Cursor Window

The content of the Cursor Window depends on cursor location.

It shows detailed information on the cursor Lat/Lon, the cursor bearing and range, the center of the screen, EBL/VRM, Guard Zone, Heading Marker and Parallel Cursor. It is hidden when the cursor is hidden.

To enable (On) or disable (Off) the Cursor Window display follow this procedure:

- [MENU] + "Radar Features" + [ENTER] + "Cursor Window" + [ENTER] + "On"/"Off" + [ENTER]

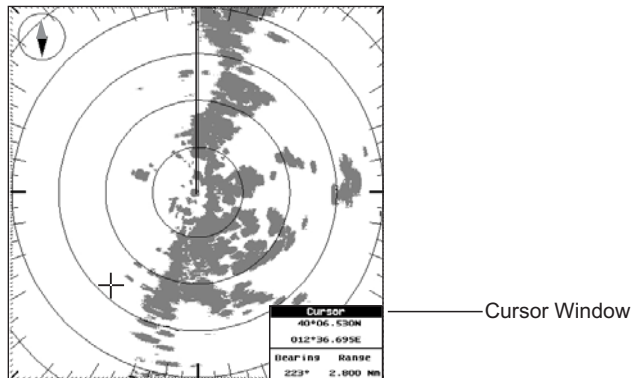

Fig. 2.3.1- The Cursor Window

2.3.2 Heading Marker

The Heading Marker (HM) is the line from the own vessel's position to the edge of the picture at the vessel's current heading with respect to the North indicated by the compass.

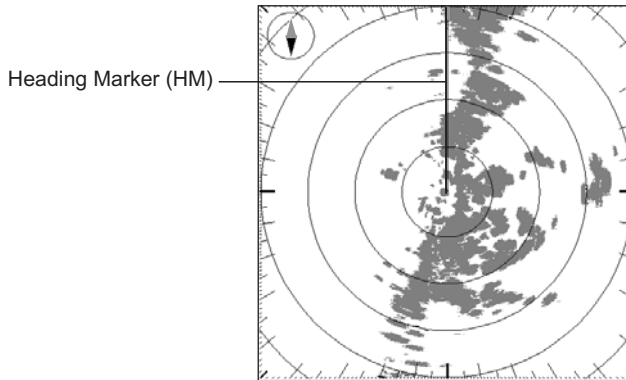

Fig. 2.3.2- The Heading Marker

The Heading Marker is updated each time the Radar image is updated. It can temporarily be hidden to check for small targets under it by positioning the Cross Cursor over it and pressing **[CLEAR]**.

To enable (On) or disable (Off) the display of the Heading Marker follow this procedure:

- **[MENU]** + "Radar Features" + **[ENTER]** + "Heading Marker" + **[ENTER]** + "On"/"Off" + **[ENTER]**

2.3.2.1 Handling of Heading Marker

Positioning the Cross Cursor on the Heading Marker activates a pop up message "HM" underneath the cursor. It is possible to select the Radar orientation among Head Up (HU), North Up (NU) or Track Up (TU) using the following software/function keys. See also the Par. 2.1.4.

- ◆ **[Head Up]**¹: The Radar picture is displayed with the vessel's current heading upwards. As the heading changes the picture will rotate.

NOTE¹ For SEAWAVE², press [2, Head Up].

- ◆ **[North Up]**¹: The Radar picture is stabilized and displayed with north upwards. As heading changes, the ship's Heading Marker moves.

NOTE¹ For SEAWAVE², press [3, North Up].

- ◆ **[Track Up]**¹: The Radar picture is stabilized and displayed with the currently selected Course Leg upwards. As heading changes, the ship's Heading Marker moves.

NOTE¹ For SEAWAVE², press [4, Track Up].

- ◆ **[Off]**¹: disables the Heading Marker.

NOTE¹ For SEAWAVE², press [1, Off].

2.3.3 Degree Scale

The Degree Scale is the graduated scale located on the most external visible range ring edge of the Radar page, with major ticks at 0, 10, 20, ..., 350 degrees and minor ticks at 5, 15, 25, ..., 355 degrees.

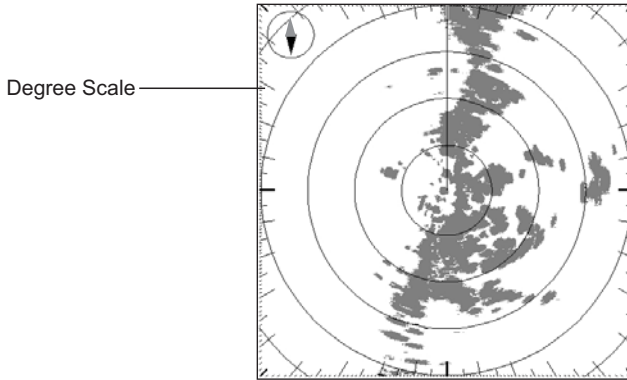

Fig. 2.3.3- The Degree Scale

To hide (Off) or unhide (On) the display of the Degree Scale follow this procedure:

- [MENU] + "Radar Features" + [ENTER] + "Degree Scale" + [ENTER] + "On"/"Off" + [ENTER]

2.3.4 Range Rings

The Range Rings are concentric rings centered on the ship position, equally spaced.

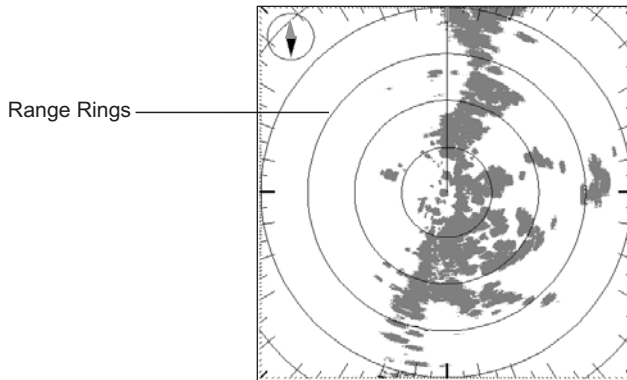

Fig. 2.3.4- The Range Rings

They are used to give an immediate idea of the range of targets from the ship. Their number and spacing are adjusted automatically accordingly with the Range Scale. The indication of the Range Rings interval is indicated in the Status Bar (see Par. 3.2).

To enable (On) or disable (Off) the display of the Range Rings follow this procedure:

- [MENU] + "Radar Features" + [ENTER] + "Range Rings" + [ENTER] + "On"/"Off" + [ENTER]

2.3.5 Compass Rose

The Compass Rose is an icon used to identify four main directions: North, South, East and West. It is North oriented.

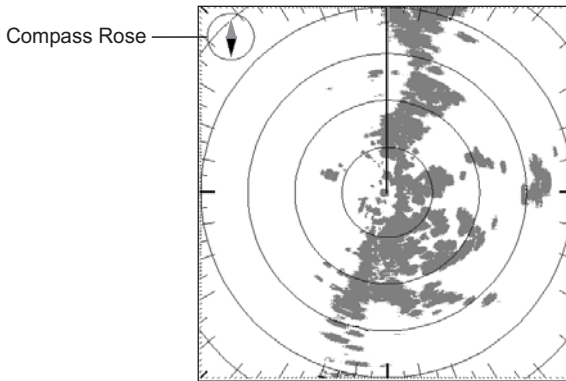

Fig. 2.3.5- The Compass Rose in the default Radar picture

NOTE Requires a heading and position sensor connected to the chart plotter

To hide (Off) or unhide (On) the display of the Compass Rose follow this procedure:

- [MENU] + "Radar Features" + [ENTER] + "Compass Rose" + [ENTER] + "On"/"Off" + [ENTER]

2.3.6 EBL & VRM

Electronic Bearing Lines (EBL) and Variable Range Marker (VRM) are used to measure the range (distance) and the bearing between two points. A standard VRM is displayed by default as a circle with its center located on your vessel's position, and EBL is displayed as a line from the vessel's position to the edge of the Radar picture display.

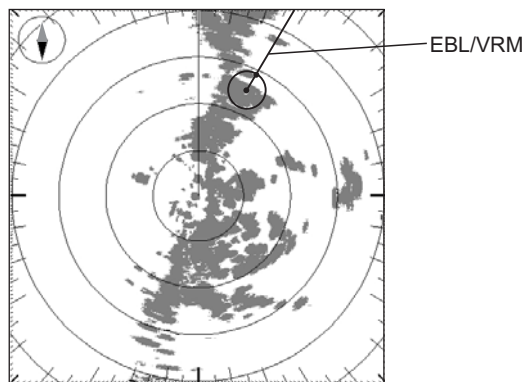

Fig. 2.3.6 - EBL & VRM display

Up to 2 EBL/VRM's may be placed on the Radar screen at the same time.

To turn EBL/VRM On or Off or to select 1 EBL/VRM, 2 EBL/VRM or both (1- 2) EBL/VRM, follow this procedure:

- [MENU] + "Radar Features" + [ENTER] + "EBL/VRM" + [ENTER] + select the desired EBL/VRM + [ENTER]

2.3.6.1 Handling of EBL/VRM

Positioning the Cross Cursor on the EBL/VRM activates a pop up message "E/V" underneath the cursor. It is possible to allow to move, hook, edit and hide it.

- ◆ **[Move]**¹: Allows moving EBL/VRM from the own ship's position to any location of the Radar page. Pressing **[Confirm]**¹ confirms the new position; pressing **[Cancel]**¹ resets the original position.

NOTE¹ For SEAWAVE³, press [1, Move]. Then press [1, Confirm] or [2, Cancel].

- ◆ **[Hook]**¹: hooks the EBL/VRM cross point allowing changing bearing and range using the Cursor Keys. Pressing **[Confirm]**¹ confirms the new range and bearing, pressing **[Cancel]**¹ resets the original range and bearing values.

NOTE¹ For SEAWAVE³, press [2, Hook]. Then press [1, Confirm] or [2, Cancel].

- ◆ **[Edit]**¹: opens an edit window to change the Offset, Angle, Range and Bearing values. Pressing **[OK]**¹ confirms the new values.

NOTE¹ For SEAWAVE³, press [3, Edit]. Then press [1, OK].

- ◆ **[Off]**¹: disables the EBL/VRM.

NOTE¹ For SEAWAVE³, press [4, Off].

2.3.7 Parallel Cursor

A set of parallel lines with first line passing through the ship's position and next lines being placed equally spaced and extending from the ship's position towards one direction.

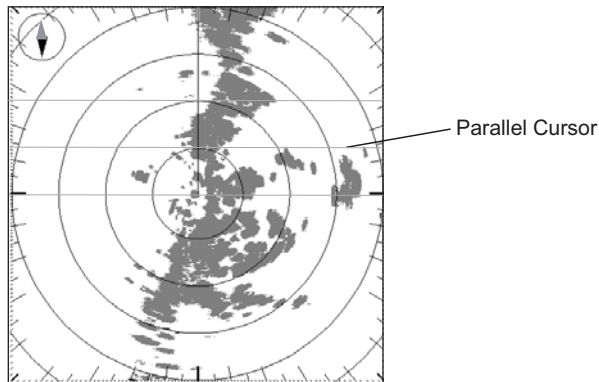

Fig. 2.3.7 - Parallel Cursor display

The user can change the angle of the lines and the range between lines. It is used to measure the bearing of other boats, navigate at a fixed distance from the coast, measure the distance between two points.

The display of the Parallel Cursor can be turned On or Off following this procedure:

- **[MENU]** + "Radar Features" + **[ENTER]** + "Parallel Cursor" + **[ENTER]** + "On"/"Off" + **[ENTER]**

2.3.7.1 Handling of Parallel Cursor

Positioning the Cross Cursor on the first line (passing through the ship's position) activates a pop up message "///" underneath the cursor.

The following software/function keys are automatically displayed:

- ◆ **[Hook]**¹: hooks the Parallel Cursor allowing changing the angle of the lines and the range between lines using the Cursor Keys. Pressing **[Confirm]**¹ confirms the new angle and range, pressing **[Cancel]**¹ resets the original angle and range values.

NOTE¹ *FOR SEAWAVE², press [1, Hook]. Then press [1, Confirm] or [2, Cancel].*

- ◆ **[Edit]**¹: opens an edit window to change the Range and Bearing values. Pressing **[OK]**¹ confirms the new values.

NOTE¹ *FOR SEAWAVE², press [2, Edit]. Then press [1, OK].*

- ◆ **[Off]**¹: disables the Parallel Cursor.

NOTE¹ *FOR SEAWAVE², press [3, Off].*

2.3.8 Center Offset

Allows to move the Radar center in any location of the screen.

To set the Center Offset follow this procedure:

- **[MENU]** + "Radar Features" + **[ENTER]** + "Center Offset" + **[ENTER]** + insert the desired value + **[ENTER]**

2.3.8.1 Handling of Center Offset

If the Radar is in Relative Motion mode, positioning the Cross Cursor on the center of the Radar image, allows editing the Center Offset ("CTR" message is shown under the cursor position). The software/function keys are automatically displayed:

- ◆ **[Move]**¹: hooks the Radar image center allowing the user, using the Cursor Keys, to move it at any location on the Radar screen. At this point pressing **[Confirm]**¹ confirms the new position of the center, pressing **[Cancel]**¹ resets the position of the Radar image at 0,0.

NOTE¹ *FOR SEAWAVE², press [1, Move]. Then press [1, Confirm] or [2, Cancel].*

- ◆ **[Offsets]**¹: opens an edit window where it is possible to edit the X Offset and Y Offset position in pixel at which the center of the screen is positioned. Pressing **[OK]**¹ confirms the new values.

NOTE¹ *FOR SEAWAVE², press [2, Offsets]. Then press [1, OK].*

- ◆ **[Ctr.Scrn]**¹: resets screen offset position to 0,0.

NOTE¹ *FOR SEAWAVE², press [3, Ctr.Scrn].*

NOTE *In True Motion mode the user cannot change the screen center position.*

2.3.9 AIS Target

To enable (On) or disable (Off) the display of AIS Target follow this procedure:

- **[MENU]** + "Radar Features" + **[ENTER]** + "AIS Target" + **[ENTER]** + "On"/"Off" + **[ENTER]**

2.4 CHART FEATURES

2.4.1 Chart Overlay Mode

Selects which cartographic objects are to be displayed when Chart Overlay function is active in Radar Full page.

The following chart presets shall be available:

- ◆ **Full**: Full cartographic representation.
- ◆ **Medium**: includes "Low" settings plus Ports & Services and Auto Chart Boundaries.
- ◆ **Low**: includes also area fills, important city names, Nav-Aids & Lights and

Underwater Object icons.

- ♦ **Minimum:** only the coast lines and elevation objects, no area fill.
- ♦ **As Cartography:** inherits settings from the current cartography setting.
- ♦ **Custom:** Custom chart representation.

To select the desired Chart Overlay Mode follow this procedure:

- [MENU] + "Chart Features" + [ENTER] + "Chart Overlay Mode" + [ENTER] + select the desired mode + [ENTER]

2.4.2 Chart Synchronization

AVAILABLE ONLY IN THE RADAR CHART SPLIT PAGE

When Chart Synchronization is enabled, the chart display is synchronized to the Radar display. This function is enabled when Home mode is active (e.g. by pressing [CLEAR] from the chart screen). An alert window showing the message "Radar - Chart Synchronization mode On" is displayed.

To enable (On) or disable (Off) the Chart Synchronization follow this procedure:

- [MENU] + "Chart Features" + [ENTER] + "Chart Synchronization" + [ENTER] + "On"/"Off" + [ENTER]

2.4.3 Cursor Echo

AVAILABLE ONLY IN THE RADAR CHART SPLIT PAGE

This function allows to correlate targets on the Radar display with objects in the chart. Moving the Radar cursor on Radar display will cause moving another cursor over the chart. The cursor over the chart shall be positioned over the same Lat/Lon of the cursor over the Radar. When the Cursor Echo function is enabled, the Radar cursor in the chart display is always shown even if the cursor in the Radar display is hidden.

To enable (On) or disable (Off) the Cursor Echo follow this procedure:

- [MENU] + "Chart Features" + [ENTER] + "Cursor Echo" + [ENTER] + "On"/"Off" + [ENTER]

2.4.4 Waypoints

When it is On, active Waypoints and their Routes are shown also overlaid over the Radar image.

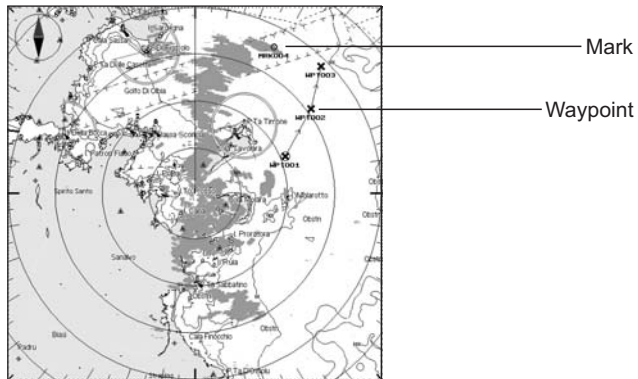

Fig. 2.4.4 - Waypoints and Marks display

To enable (On) or disable (Off) the display of Waypoints follow this procedure:

- [MENU] + "Chart Features" + [ENTER] + "Waypoints" + [ENTER] + "On"/"Off" + [ENTER]

2.4.5 Marks

When it is On, active Marks are shown also overlaid over the Radar image. See the previous figure, Fig. 2.4.4.

To enable (On) or disable (Off) the display of Marks follow this procedure:

- [MENU] + "Chart Features" + [ENTER] + "Marks" + [ENTER] + "On"/"Off" + [ENTER]

2.4.6 Info on Objects

If enabled, moving the Cross Cursor in any location around the screen cause the chart plotter to search into its database for Cartographic Objects located within a certain range from the cursor position. The Quick Info Window showing the details of the objects found is automatically opened. Pressing [CLEAR] closes the Quick Info Window.

To enable (On) or disable (Off) the display of Info on Objects follow this procedure:

- [MENU] + "Chart Features" + [ENTER] + "Info on Objects" + [ENTER] + "On"/"Off" + [ENTER]

2.5 GUARD ZONES

Your Radar allows a function to help you avoid a collision. It is possible to set an alarm to trigger when a target is within a specified zone, the Guard Zone. It is allowed to display up to 2 Guard Zones, Sector or Circular.

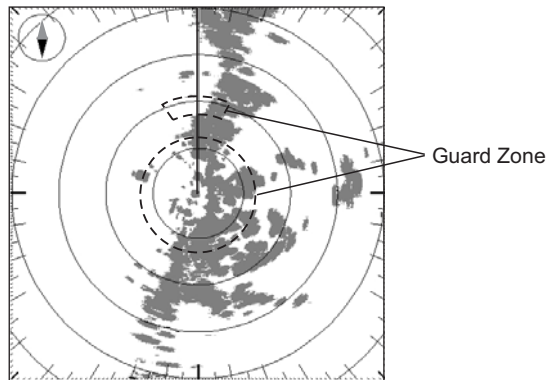

Fig. 2.5 - Guard Zone display

When a Guard Zone is active, the Guard Alarm sounds when a target enters its area.

NOTE *A Guard Zone only operates when the whole zone is displayed on the screen. Moreover, a Guard Zone is inactive for 10 seconds after it is placed or re-sized, to avoid inappropriate alarms during positioning.*

To select the desired Guard Zone (or to disable), follow the procedure:

- [MENU] + "Guard Zones" + [ENTER] + "Guard Zone 1"/"Guard Zone 2" + [ENTER] + select the desired type of Guard Zone between Sector or Circular (or select Off to disable) + [ENTER]

2.5.1 Handling of Guard Zone

Positioning the Cross Cursor over a Guard Zone, causes the message "GZ" to be displayed under the cursor. It is possible to handle the Guard Zone.

- ◆ [Hook]': allows changing Guard Zone range by moving up/down Cursor

Keys. Pressing **[Confirm]**¹ confirms the new range, pressing **[Cancel]**¹ resets the original range value.

NOTE¹ *FOR SEAWAVE³, press [1, Hook]. Then press [1, Confirm] or [2, Cancel].*

- ◆ **[Type]**¹: allows changing Guard Zone type: press **[Sector]**¹ to select the Sector Guard Zone, press **[Circular]**¹ to select the Circular Guard Zone.

NOTE¹ *FOR SEAWAVE³, press [2, Type]. Then press [1, Sector] or [2, Circular].*

- ◆ **[Off]**¹: disables the Guard Zone.

NOTE¹ *FOR SEAWAVE³, press [3, Off].*

2.5.2 Guard Zone Sensitivity

It defines a limit (selectable from 0 to 100) under which echoes activate an alarm condition, when detected inside a Guard Zone. Guard Zone Sensitivity default is 50. The value 100 is the most sensitive (the system is always on, every detected echo cause an alarm condition) and the value 000 is the least sensitive (same as switching the alarm off).

To select the desired Guard Zone Sensitivity, follow this procedure:

- **[MENU] + "Guard Zones" + [ENTER] + "Guard Zone 1 Sensitivity"/"Guard Zone 2 Sensitivity" + [ENTER] + insert the desired value + [ENTER]**

3. Radar Pages

This section will assist you to select the preferred Radar page.

NOTE *The Radar display page is available only if the Radar is connected and powered On, and the Radar is in Transmit mode (see Chapter 1).*

3.1 PAGES SELECTION

The Page Selection menu allows you to change the Radar page displayed. To access this menu:

- [PAGE] + "Radar" + [ENTER] + select the desired page + [ENTER]

MARLIN:

- [DATA] + "Radar" + [ENTER] + select the desired page + [ENTER]

EXPLORER³:

- [MENU] + "Page" + [ENTER] + "Radar" + [ENTER] + select the desired page + [ENTER]

The menu now shows the selections related to the Radar: Radar Full page ("Radar"), Radar Split Chart page ("Radar/Chart"), Radar Split Fish Finder page ("Radar/FF"), Radar Split Highway page ("Radar/Nav. Data"), Radar Combo pages ("Radar/FF/Chart/Nav" and "Radar/FF/Chart/Video"). Move the cursor to select the desired item and then press [ENTER].

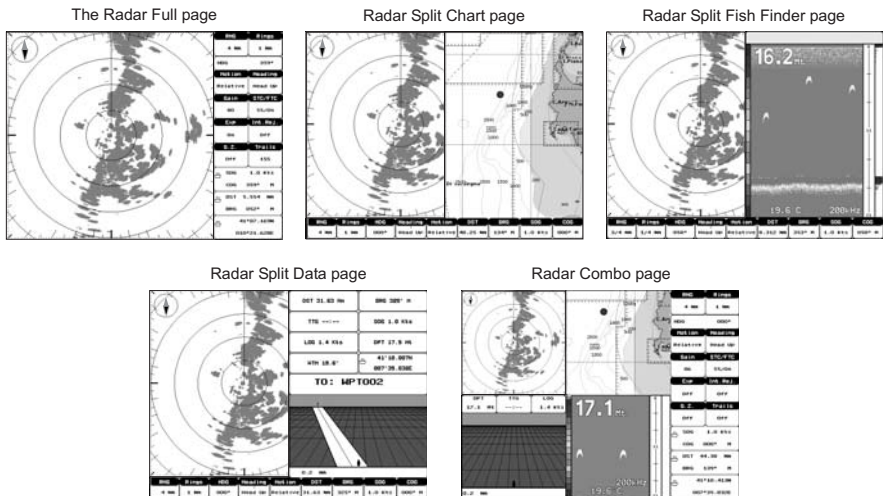

Fig. 3.1 - Examples of Radar pages

3.1.1 Selection by Software/Function Key

The default soft keys configuration can be customized. When the Radar is connected, any soft key can be assigned any of the Radar pages.

From the Chart page, pressing and holding down any of the four soft key shows a pop-up window on the top of the soft key pressed that contains all possible data

pages assignable to the soft key pressed.

Only For SEAWAVE³:

In all data pages the user can customize the Function Keys. Pressing and holding down for 1 second the numeric key **[1]**, **[2]**, **[3]**, **[4]**, **[5]** it will be possible to assign a different selection to the relative Function Key.

Move the Cursor key up/down to place the selector on the desired item; move the Cursor key to the right or press **[ENTER]** to set the selected item; move the Cursor key to the left or press **[CLEAR]** to close the pop-up window. See the example displaying in the picture below, the four soft keys are customized to select four among the available Radar pages:

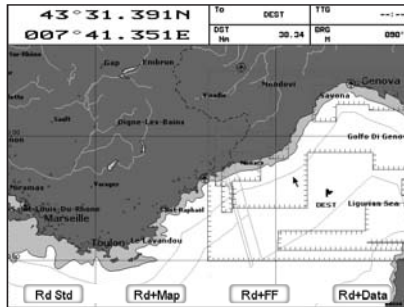

Fig. 3.1.1 - Example of Radar page selection by Soft Key on SW1101

Press **[Rd Std]** to show the Full page, **[Rd+Map]** to show the Radar Split Chart page, **[Rd+FF]** to show the Radar Split Fish Finder page, **[Rd+Data]** to show the Radar Split Data page. It is possible another choice, **[Combo 4]** to show the Radar/Chart/Fish Finder/Highway page.

3.2 STATUS BAR

You may choose to select the data displayed in the boxes in the system set up.

- ① RNG (Radar Range) and Range rings interval
- ② Current Heading
- ③ Motion Mode and Heading Mode indication
- ④ Gain and STC/FTC indication
- ⑤ Expansion and Interference Rejection
- ⑥ Guard Zone alarms and Trails
- ⑦ Ship Speed Over Ground and Course Over Ground
- ⑧ Ship Distance and Bearing from destination
- ⑨ Ship Lat/Lon
- ⑩ Cursor Window

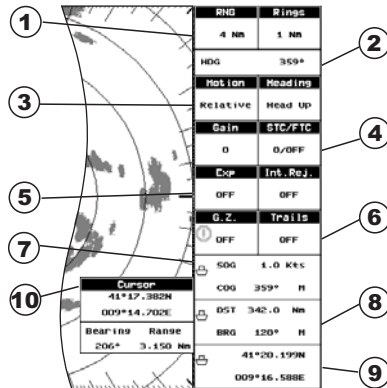

Fig.3.2 - The Default Status Bar

4. Technical Specifications

This chapter provides specifications of the several types of Radar.

4.1 SWR 1

Antenna unit

- ◆ Power supply : 10.8 to 31.2 VDC
- ◆ Power consumption : 30W or less
- ◆ Preheat times : 90 sec
- ◆ Aerial : Radome 0.9 Feet
- ◆ Peak power output : 2kW
- ◆ Transmitting frequency : 9445+/-30MHz
- ◆ Beam width (degree)
 - Horizontal : 7°
 - Vertical : 25°
- ◆ Side Lobes Within +/-10° : <=-20dB
- ◆ Rotation : 30rpm
- ◆ Pulse Length (μsec)/PRF (Hz)
 - S : 0.1/2200
 - M, M1 : 0.3/1100
 - L, M2 : 0.8/550
- ◆ IF center frequency : 60MHz (Linear amplifier)
- ◆ IF bandwidth
 - S : 6MHz
 - M, M1 : 6MHz
 - L, M2 : 3MHz
- ◆ Noise figure : 10dB nominal
- ◆ Operating Temperature : -25°C ~ +55°C
- ◆ Operation in wind (relative) : 100 knots
- ◆ Water Resistance : IPX6 (IEC60529)
- ◆ Preheat times output (by 5 sec step) : 85 sec to 5 sec

Dimensions and Mounting

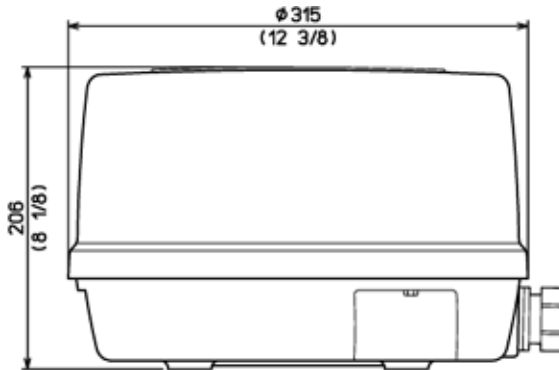
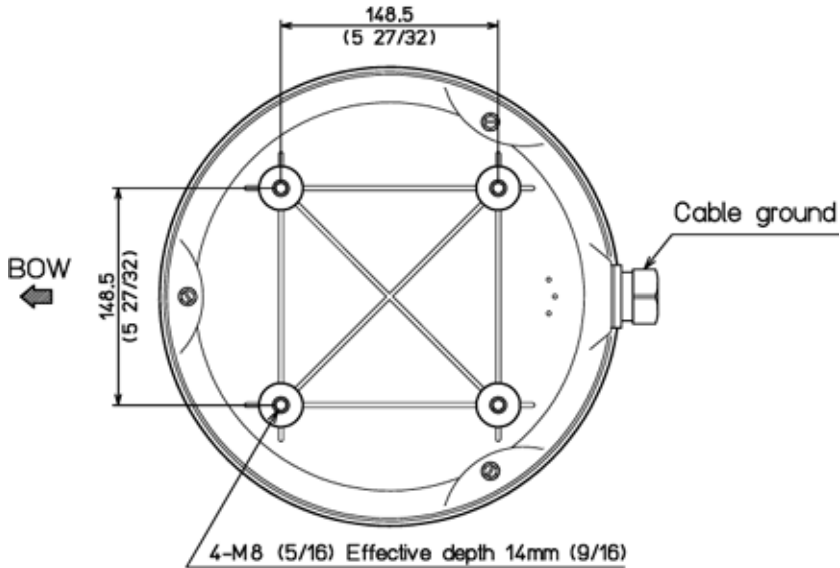

Fig. 4.1 - Radar SWR 1 (I)



Weight: 4.5 kg (10 lb) without cable
 Weight: 5.5 kg (12.5 lb) 10m cable included

Fig. 4.1a - Radar SWR 1 (II)

4.2 SWR 8

Antenna unit

◆ Power supply		: 10.8 to 41.6 VDC
◆ Power consumption		: 30W or less
◆ Preheat times		: 90 sec
◆ Aerial		: Radome 1.5 Feet
◆ Peak power output		: 2kW
◆ Transmitting frequency		: 9445 +/- 30MHz
◆ Beam width (degree)	Horizontal	: 4.7°
◆	Vertical	: 25°
◆ Side Lobes Within +/-10°		: < -20dB
◆ Rotation		: 30rpm
◆ Pulse Length (μsec)/PRF (Hz)	S	: 0.1/2200
◆	M, M1	: 0.3/1100
◆	L, M2	: 0.8/550
◆ IF center frequency		: 60MHz (Linear amplifier)
◆ IF bandwidth	S	: 6MHz
◆	M, M1	: 6MHz
◆	L, M2	: 3MHz
◆ Noise figure		: 10dB nominal
◆ Operating Temperature		: -25°C ~ +55°C
◆ Operation in wind (relative)		: 100 knots
◆ Water Resistance		: IPX6 (IEC60529)
◆ Preheat times output (by 5 sec step)		: 85 sec to 5 sec

- ♦ L, L1 : 1.0/500
- ♦ IF center frequency : 60MHz (Linear amplifier)
- ♦ IF bandwidth S : 6MHz
- ♦ M, M1 : 6MHz
- ♦ L, M2 : 3MHz
- ♦ L, L1 : 3MHz
- ♦ Noise figure : 6.0dB or less
- ♦ Operating Temperature : -25°C ~ +55°C
- ♦ Operation in wind (relative) : 100 knots
- ♦ Water Resistance : IPX6 (IEC60529)
- ♦ Preheat times output (by 5 sec step) : 115 sec to 5 sec

Dimensions and Mounting

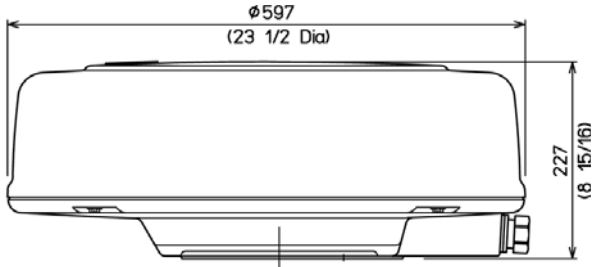
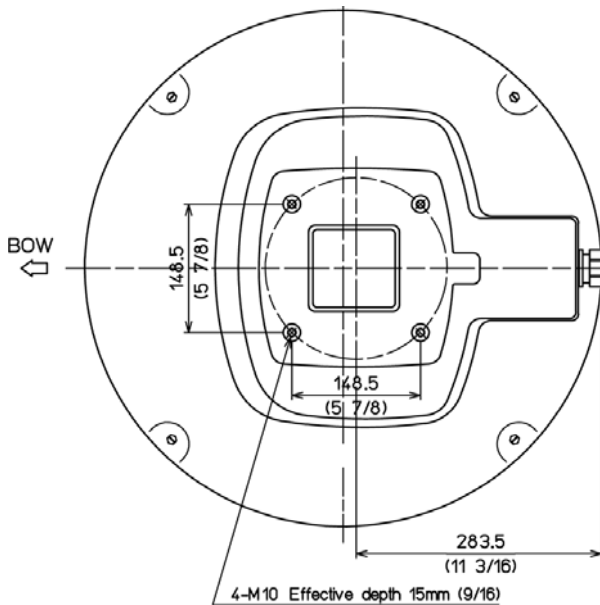

Fig. 4.3 - Radar SWR 9 (I)



Weight: 9.7 kg (21.5lb) 10m cable included
 Weight: 8.4 kg (19.0lb) without cable

Fig. 4.3a - Radar SWR 9 (II)

4.4 SWR 10

Antenna unit

◆ Power supply		: 10.8 to 41.6 VDC
◆ Power consumption		: 80W or less
◆ Preheat times		: 120 sec
◆ Aerial		: Open 3.5 or 4.5 Feet
◆ Peak power output		: 4kW
◆ Transmitting frequency		: 9410 +/-30MHz
◆ Beam width (degree)	Horizontal	: 2.4° or 1.7°
◆	Vertical	: 25°
◆ Side Lobes	Within +/-10°	: <=-23dB
◆	Outside +/-10°	: <=-32dB
◆ Rotation		: 24rpm
◆ Pulse Length (μsec)/PRF (Hz)	S	: 0.06/4000
◆	M, M1	: 0.15/2000
◆	L, M2	: 0.4/1000
◆	L, L1	: 1.0/500
◆ IF center frequency		: 60MHz (Linear amplifier)
◆ IF bandwidth	S	: 20MHz
◆	M, M1	: 20MHz
◆	L, M2	: 5MHz
◆	L, L1	: 5MHz
◆ Noise figure		: 5.0dB or less
◆ Operating Temperature		: -25°C ~ +55°C
◆ Operation in wind (relative)		: 70 knots
◆ Water Resistance		: IPX6 (IEC60529)
◆ Preheat times output (by 5 sec step)		: 115 sec to 5 sec

Dimensions and Mounting

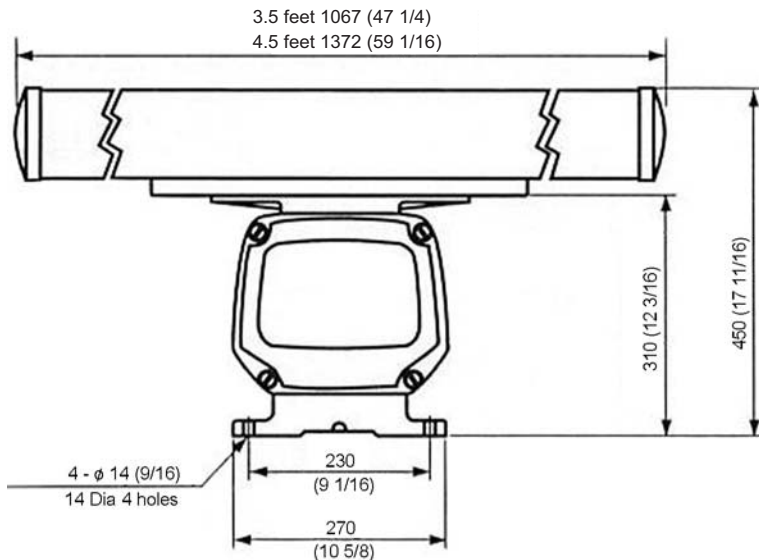
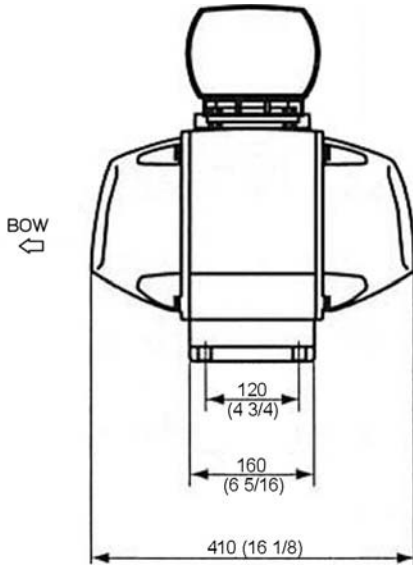

Fig. 4.4 - Radar SWR 10 (I)



Weight: 21.2 Kg (47lb) 4 feet
Weight: 21.9 Kg (49lb) 5 feet

Fig. 4.4a - Radar SWR 10 (II)

5. Troubleshooting

5.1 The Radar page is not available

This means you didn't configure the I/O setup to connect to the Radar. Enter the I/O Setup menu (see procedure at Par. 1.7.1) and select the Radar on the serial port to which the Radar is connected.

5.2 The message "Please Turn On Radar" is displayed on the Radar window

This means that even if the I/O Setup has been configured for Radar, no Radar is being detected. This may depend on several factors:

- ♦ Verify that the correct serial port is set in the I/O Setup menu, eventually try setting the Radar on another serial port.
- ♦ Check that the Radar is connected to the chart plotter, to the same serial port as set in the I/O Setup menu, in case try connecting it to another serial port.
- ♦ Verify that all the connections in the Junction Box are done properly.
- ♦ Verify using a Voltage Meter that the Radar power supply level at the Junction Box is at least 12V. The Radar is able to operate with 10V but some volts may be dropped due to the cable length.

If everything above is correct, try shorting the green and the blue wires in cable coming from the Radar. If the Radar still doesn't work you need to call for assistance.

5.3 The Radar preheating countdown timer is displayed but when the preheating terminates it restarts over and over again

The power supply level is too low. This may be caused by battery low, cable too long, cable section too narrow.

5.4 Too much clutter near the Radar screen center

This is a typical phenomenon with Radar. Echoes from nearby vessel may hit other objects like other vessels or other objects randomly and reflections can be received by Radar antenna due to very short distance between the objects. This is normal condition in a port where nearby targets (such as sailboat masts) may cause multiple reflections. In this case, increase the STC and decreasing the GAIN.

5.5 During navigation in open sea the center of the screen is covered by a large spot

It means that most probably the Transmission Trigger Delay and/or the Main Bang Suppression need to be correctly tuned (refer to Par. 1.7.4.4).

5.6 After turning transmission On, the Radar page remains completely black

The Gain setting could be too low or STC setting too high. The Radar is probably not properly tuned. Execute the Automatic Tuning procedure to restore optimal performance (refer to Par. 1.7.4.5).

5.7 The Radar sensitivity appears to be low

Radar sensitivity depends on several factors. To increase sensitivity act as follows:

- ♦ Execute the Automatic Tuning procedure to ensure that the Radar is perfectly tuned.
- ♦ Increase the GAIN.
- ♦ Reduce the STC, since the STC has the effect to reduce the echo intensity of nearby targets.
- ♦ Turn Off the FTC, since it has the effect to reduce the echoes intensity of big targets.

5.8 Radar targets are delayed with respect to the antenna rotation

The Radar image on the GPS is updated every 2.5 seconds as information is acquired from the antenna. This could cause a mis-match between the actual target position and the targets shown on the screen.

5.9 Radar target appear to be pulsing

This is a rather common problem for any Radar. For long distance targets, when the Radar pulse hits a target, the reflection strength which depends on the hit angle. Perpendicular hits give the strongest echo. Hard objects give stronger echo and soft objects give weaker echo.

To eliminate the pulsing effect of Radar targets the Echo Trails function may be used (see Par. 2.1.6).

5.10 Stationary target appear to be oscillating around their actual position

Radar targets may appear to be oscillating around their actual position due to the movement of your vessel. In fact even a minimum oscillation of the position where the Radar is located may cause an apparent movement of the targets detected.

For short distance targets, surface waves lower the detectivity. The STC should be adjusted to properly to maximize the detectivity.

6. Frequently Asked Questions

6.1 What should I do at first Radar installation?

At first installation its necessary to:

- 1) properly set up the Radar calibration
- 2) set up the I/O to detect the Radar

6.2 How can I turn Radar power On/Off

Radar power On/Off can be either directly controlled from the chart plotter or by an external switch depending on how you have set up your chart plotter.

In case the power is managed by the chart plotter you can turn power On by pressing **[MENU]** when in the Radar Page. Otherwise you have to turn power On by acting on the external switch.

NOTE *For a practical matter we suggest to use Radar Powered On/Off controlled by an external switch, because at a glance we can check the Radar status without having to switch to the Radar page.*

6.3 How should I setup the chart plotter to control the Radar power On/Off?

Please refer to Chapter 1 for wiring schematic.

6.4 How can I turn Radar Transmission On/Off?

Press **[ENTER]** in the Radar page or enter the Radar Main Menu and set Transmission On from the related menu voice. Transmission can be set in Stand-by only from the Radar menu.

6.5 What is the preheating?

Each time you power On the Radar you must allow 90 to 120 seconds (depending on the Radar model) to warm up the Radar. Operating the Radar before this time could cause damage to it. For this reason the chart plotter doesn't allow operating the Radar until the preheating is complete.

6.6 Some time the preheating takes less than 90 seconds, is this normal?

Yes it is. It means that the Radar was already powered on at the time you turned On the chart plotter so the preheating started before.

6.7 What is the Radar calibration?

Radar calibration is a set of options that allows to properly set the Radar to work on your boat. You can set up the Heading correction, to compensate of orientation errors due to the installation, the Radar trigger delay to properly adjust the Radar beam as to correctly measure ranges, and finally the sensitivity of the Radar to maximize the Radar sensitivity.

6.8 When and how should I adjust the Radar heading?

At first installation you should correct the Radar heading as to ensure that it is perfectly aligned with your bow.

6.9 When and how should I adjust the Radar Trigger delay?

At first installation. It is required to ensure the Radar is capable to perfectly measure ranges and avoid distortions. Please follow the procedure described at Par. 1.7.4.4.

6.10 When should I do the Radar tuning?

Radar tuning is generally not necessary since it is already tuned at the factory. However in the long run or in case some components are replaced it could be necessary to perform tuning to achieve the maximum sensitivity.

6.11 Should I use the Manual or Auto Tuning?

We strongly suggest to use the Auto Tuning that generally is capable to give optimal results.

6.12 How should I do the Manual Tuning?

Follow procedure at Par. 1.7.4.5.

6.13 What is the STC, and how should I operate it?

STC is the Sensitivity Time Constant. It is used to reduce the sensitivity and thus the clutter in the range closer to the Radar. Operate the STC as to reduce the echoes coming from the closer ranges to an acceptable level.

6.14 What is the FTC and how should I operate it?

FTC is the Fast Time Constant. It is used to reduce the echoes coming from large objects that can hide other small objects. It is also called the rain control since it is capable to reduce the effects of the rain on the display.

6.15 What is the MBS?

The MBS is the Main Bang Suppression. It is used to suppress the stronger echoes caused by Radar transmission in the receiver. It is like the STC but its operates in a shorter range.

6.16 I can't turn Chart Overlay On, why?

To turn Chart Overlay On you must have both a GPS and a heading sensor connected to the chart plotter. If the chart plotter doesn't detect such devices it will automatically disable the Chart Overlay option.

6.17 I can't set the North Up or Course Up navigation mode, why?

To turn On the North Up or Course Up navigation modes you must have both a GPS and a heading sensor connected to the chart plotter. If the chart plotter doesn't detect such devices it will automatically disable such option.

6.18 I can't set up the True Motion mode, why?

To turn On the True Motion mode you must have both a GPS and a heading sensor connected to the chart plotter. If the chart plotter doesn't detect such devices it will automatically disable such option.

6.19 Why do I need a Heading Sensor and a GPS to use all Radar functionalities?

Because the Radar need to know the current position of the boat and its current heading.

6.20 What are the functions that require a GPS or a Heading Sensor?

Function	Heading	GPS FIX
North Up Radar orientation	Y	N
Track Up Radar orientation	Y	N
True Motion mode	Y	Y
Chart Overlay	Y	Y
Radar/Chart Synchronization	Y	Y
Cursor Echo	Y	Y
Head Up Mode	N	N
Relative Motion mode	N	N

6.21 Is it better a gyrocompass or a flux gate compass?

The gyrocompass it is a better choice because it is faster but it is much more expensive. The flux gate compass is slower but it is much cheaper. Using a flux-gate you have to expect to see delays in the rotation of the chart when in Chart Overlay mode.

6.22 How can I be advised of potential dangers for the navigation?

Using the Guard Zone alarms.

6.23 What are Guard Zones?

Guard Zones are zones defined by the user that causes an audible and visual alarm to be triggered when a target exceeding a certain density enters into it. The density of the target that may trigger the alarm is regulated by mean of the Guard Zone sensitivity. There are of two types of Guard Zones: Circular or Sectorial. They are fixed with respect to the ship position and heading but their range and orientation (only for sector type) are user defined.

6.24 How should I set the Guard Zone sensitivity?

Guard Zone sensitivity must be regulated accordingly to the current Gain of the Radar. The higher the sensitivity the smaller the target that may trigger the alarm. In general if you regulated your Radar to obtain a clean picture you can set the Guard Zone sensitivity very high to detect even the smaller targets. In case the Radar picture has clutter present due to the higher gain set, you'll have to reduce the Guard Zone sensitivity to avoid triggering false alarms. In general a way to set the maximum sensitivity for a Guard Zone is to start increasing the sensitivity until an alarm is triggered and then reduce the sensitivity until the alarm stops.

A. What is Radar?

A.1 GENERAL

The word “radar” is an acronym for “RADio Detecting And Ranging.” In very simple terms, this is how it works. A radio transmitter sends a quick microwave pulse, and then a receiver listens for that signal’s echo when it is bounced back from something in its path. The returning signal is processed by a computer to determine its relative distance, position and bearing. This information is graphically displayed on a screen for you to see. Other boats or ships, navigational markers, landmasses and such are referred to as targets.

By knowing how long it takes for a signal to return, the distance to a target can be determined. As the Radar antenna scans through a 360-degree rotation, it can show where the target is relative to your position. By repeated scans, you can see which direction another vessel is moving.

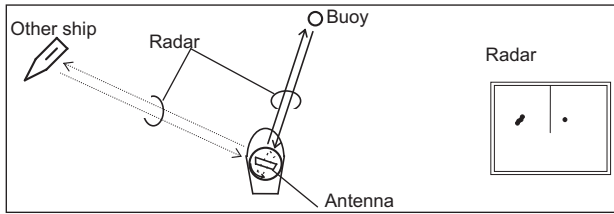

Fig. A.1 - Radar

A.1.1 Antenna

How Radar will perform is largely determined by its antenna or scanner. Increasing the size of the antenna improves long-range performance and target discrimination, or the ability to distinguish two separate targets at a distance. The critical factors are the antenna’s beam width and side lobe level. Typically, a Radar antenna will radiate a tightly focused beam from the front of the array. The longer the antenna array is, the narrower the beam width will be.

Additionally, it will also emit smaller amounts of energy to each side. The lower the side lobe level, the less the effect of a false echo.

A.1.2 Side Lobe

The beam in which the strongest radio signal is radiated from the antenna is called the “main lobe”. Those beams that are radiated in other directions are referred to as the “side lobes”. The side lobe level refers to the difference in level (signal strength) between the largest side lobe and the main lobe.

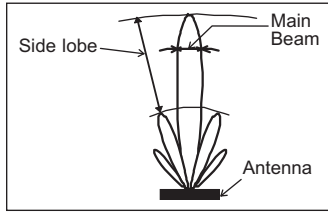

Fig. A.1.2 - Antenna Pattern

A.2 CHARACTERISTICS OF RADAR WAVE

Radio waves travel out from the antenna while bending slightly along the earth's surface. The amount they bend depends on atmospheric conditions. The sight distance of a Radar generally is about 6% longer than the optical sight distance and is calculated using this equation:

$$\text{Radar sight distance (NM)} = 2.22 (\sqrt{\text{antenna height (m)}} + \sqrt{\text{target height (m)}})$$

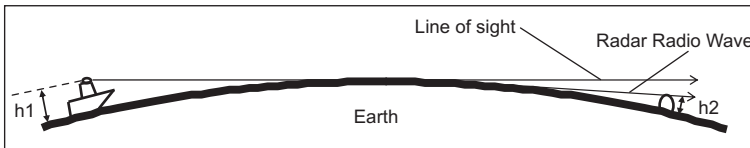

Fig. A.2 - Radar wave

A.2.1 Targets difficult to display on screen

The intensity of the reflected radio signal from a target depends on the distance, height, and size of the target, as well as its material and shape, along with the Radar's transmitter power output and antenna size. Targets made of fibreglass, wood, or other low-reflectance materials or those that have a small incident angle are difficult to display on a screen. Sandy beaches, and sandy or muddy shallows can be difficult to catch. Because there's not much to reflect a signal back to you, a coastline can actually be closer to your boat than it appears on the screen.

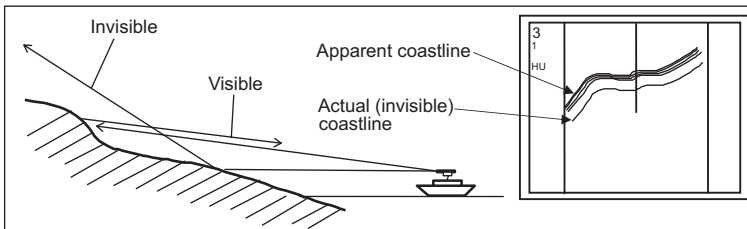

Fig. A.2.1 - Targets difficult to display on screen

A.2.2 Shadow zones of Radar

Radar waves propagate in a straight line. A high outcropping of land or a large ship will create a shadow zone behind it and prevent you from seeing targets on the other side. More importantly, if a mast or some part of the boat's superstructure is in the path of the antenna's sweep, this will also create a shadow zone. No targets will be recognized behind it and it could create a dangerous situation.

A.2.3 False echoes

Sometimes Radar will display targets on screen that do not exist in the real world. You should be aware of how and why this happens.

A.2.3.1 Ghost echoes

Sometimes one large object very near your boat will appear as two different targets on screen. One is the actual Radar echo. The other is a ghost echo generated by a re-reflection of the original signal. It comes back to your own boat, bounces back to the target, and then is picked up by the antenna on the second bounce. The actual echo appears at the correct distance and bearing on the screen. The ghost echo appears somewhere behind your boat. This type of false echo is also generated by re-reflection of waves from bridges, break walls or building along shore.

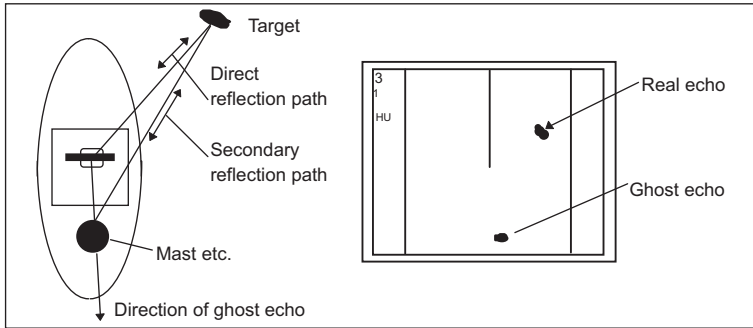

Fig. A.2.3.1 - Ghost Echoes

A.2.3.2 Multiple echoes

If there is a large vertical reflecting surface near your boat, as in the case when you pass alongside a large ship, Radar signals are repeatedly bounced back and forth between your boat and the other object. Two to four images appear on the screen at equal intervals in the same bearing. This is called a multiple echo. The image appearing closest to you is the real echo. Multiple echoes will disappear as you move away from the reflecting object or its bearing changes.

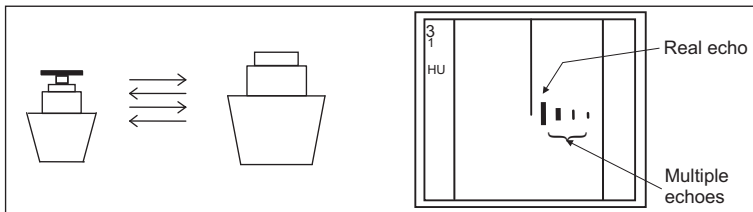

Fig. A.2.3.2 - Multiple Echoes

A.2.3.3 False echoes caused by side lobe

An antenna's side lobe emissions are low power, and will not register distant targets. However, if there is a strong reflecting target near your boat, it sometimes may appear as a circular-arc false echo on the screen.

WARNING

When near large targets or land, your boat's mast may sometimes appear as circular-arc shaped false echo.

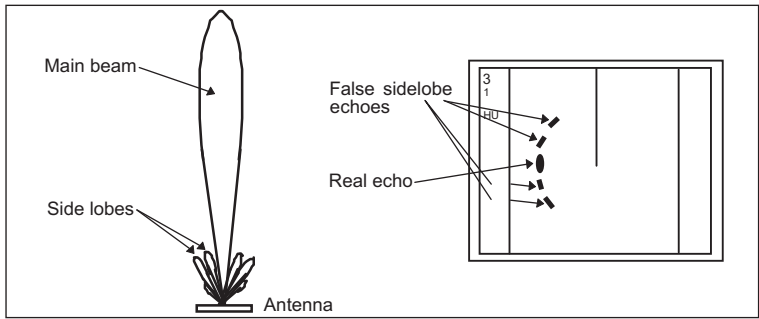

Fig. A.2.3.3 - False Echoes caused by side lobe

A.2.3.4 Distant False echoes caused by duct phenomenon

The duct phenomenon sometimes occurs when meteorological conditions create a temperature inversion between layers of air. When this happens, Radar waves propagate erratically and can reach a location considerably farther away from your boat than the Radar's maximum distance range. What appears on screen is a false echo that looks to be nearer than the actual target. Since the true echo from the distant target is outside the measurement capabilities of the Radar, its apparent distance will change when you change ranges, and you can conclude that it's a false echo.

A.2.3.5 Radar interference

If another boat's Radar is operating on the same frequency as yours, it can create interference on your display. The interference usually appears as spiral or radial patterns. This Radar has an interference rejection control to eliminate interference. Turn it on to reduce or eliminate the interference.

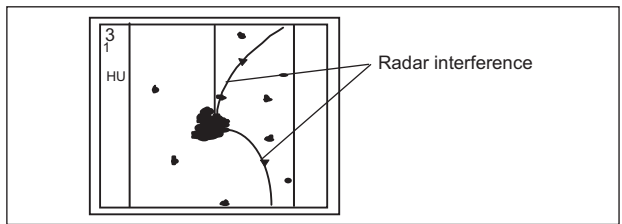

Fig. A.2.3.5 - Radar interference

B. Installation

B.1 MORE INSTALLATION CONSIDERATIONS

B.1.1 Shifting from keel line

By shifting the scanner position from the keel line to the starboard side of the boat, it is possible to move shadow zones to the port side. This makes it possible to keep a clear view to the bow. The distance to be shifted can be calculated using the following equation:

$$L_s = 0.4R + D/2 \text{ [m] (when } R < 15\text{m)}$$

$$L_s = 0.025R + D/2 \text{ [m] (when } R \geq 15\text{m)}$$

where L_s = distance to be shifted from keel line

D = diameter of obstacle on keel line

R = distance from scanner to obstacle

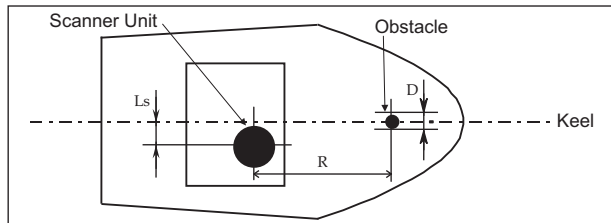

Fig. B.1.1 - Shifting from keel line

B.1.2 Obtaining sufficient dip angle

Raise the scanner position so that there is a sufficient dip angle available between the line of sight from the scanner to the obstacle and the horizontal line. By raising the dip angle above 5° , it is possible to prevent mid- and long-distance shadow zones. The Radar cannot detect objects below the line of sight.

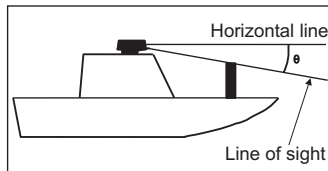

Fig. B.1.2 - Obtaining sufficient dip angle

B.2 INSTALLING SCANNER UNIT

Use a mounting base such as the ones shown in Fig. B.1.1, or you can install the scanner directly to a roof or other flat surface. Be certain you keep the water drain tube clear. It's located at the bottom of the scanner unit.

NOTE *If the mounting bracket or surface has a curvature of more than 2mm, use spacers with the mounting bolts to prevent stress on the scanner housing.*

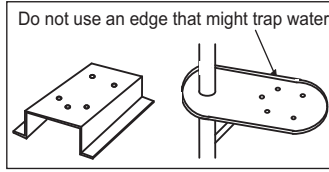

Fig. B.2 - Installing scanner unit

Analytical Index

A

AIS Target	29
Antenna	49
Antenna Parking Position	14
Antenna unit	37, 38, 39, 41
Automatic Tuning	18, 19, 43, 44, 46

C

calibration	14, 45
Center Offset	29
Chart Overlay	21, 46
Chart Overlay Mode	29
Chart Plotter Software	13
Chart Synchronization	30
Clear RAM	18
clutter	43
compass	47
Compass Rose	26
Conventions	7
Course Tuning	19
Course Up	46
Cross Cursor	21
CTR	29
Cursor	21
Cursor Echo	30
Cursor Window	24

D

dangers	47
Degree Scale	25
Dimensions	37
duct phenomenon	52

E

EBL	27
Echo Trails Settings	23
External Switch	13, 45

F

False echoes	51
Fast Time Constant	46
Fine Tuning	19
First Installation	18, 45
flux gate compass	47
focus	35
FTC	24, 44, 46
Functions	21

G

GAIN	16, 23, 43, 44
Ghost echoes	51
Guard Zone	31, 47
Guard Zone Sensitivity	47
gyrocompass	47

H

Head Up	22, 25
heading	45
Heading Marker	25
Heading Sensor	46
HM	25
HU	22, 25

I

I/O Setup	13, 43
Info on Objects	31
Info on Points	31
Installation	9, 45, 53
Interference Rejection	23

J

Junction Box	11, 43
--------------------	--------

M

Main Bang Suppression	24, 43, 46
Manual Tuning	18, 46
Mark	31
MBS	16, 24, 46
MBS Adjustment	24
MEDIA	20
Motion Mode	22, 46
Mounting	10, 37, 39, 40, 41
Multiple echoes	51

N

North Up	22, 25, 46
NU	22, 25

O

Orientation	22
-------------------	----

P

Packing List	8
Parallel Cursor	28
port	13
Power Connections	13
Power consumption	37, 38, 39, 41
power On/Off	45
Power supply	37, 38, 39, 41
Powered On	13
Preheat	37, 38, 39, 41, 43, 45

R

Radar	49
Radar calibration	45
Radar Full page	35
Radar interference	52
Radar page	33, 43
Radar Trigger delay	46
Radar tuning	46
Range	22
Range Rings	26
Relative Motion	22

S

scanner	49, 53
Sector Transmission Off	15
Sensitivity	23, 32, 44
Sensitivity Time Constant	46
serial port	43
Shadow zone	50
Side Lobe	37, 38, 39, 41, 49, 51
Soft Key	33
Specifications	37
Status Bar	29

STC	19, 23, 43, 44, 46
T	
Target	44, 50
Target Expansion	23
Track Up	22, 25
Transmission	14
Transmission On	43
Transmission On/Off	45
Transmission Trigger Delay	43
Troubleshooting	43
True Motion	22, 46

TTD	15
TU	22, 25
Tune control	18
Tuning	15, 46
Turn On Radar	43

V	
VRM	27

W	
Warming Up	14
Waypoint	30